

Smart Lock User Manual

Model:H13-TB

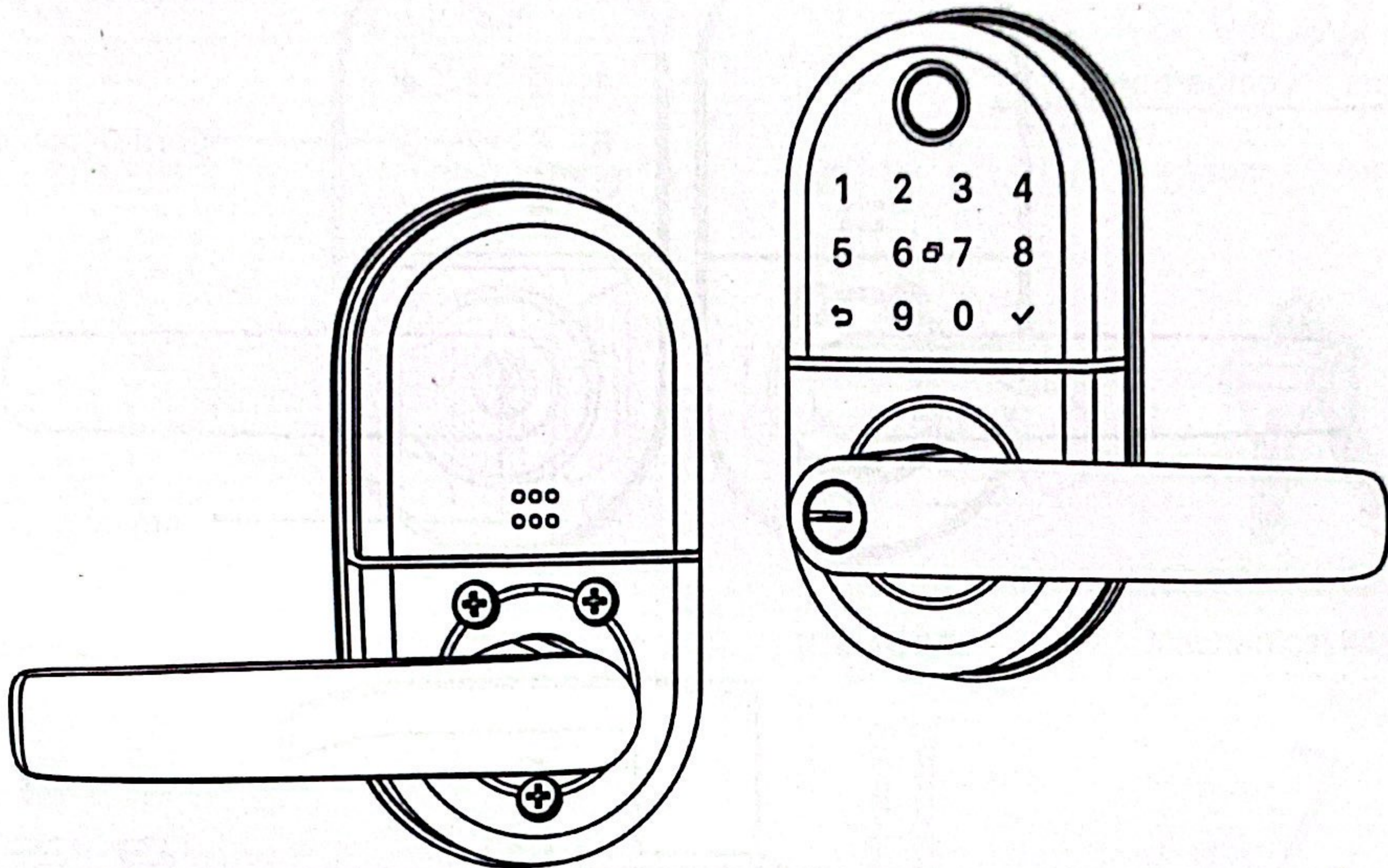

IMPORTANT NOTES

1. Install and test the lock with the door open to avoid being locked out.
2. DO NOT install the batteries before installing the lock!
3. Follow the instructions in sequential order!
4. Please must use AA Alkaline Battery and don't use Lithium Battery or Rechargeable Battery.
5. Please replace for the battery when low wattage alarm.
6. Reading this manual carefully before installation, and keep it for future reference.

1. Product Overview

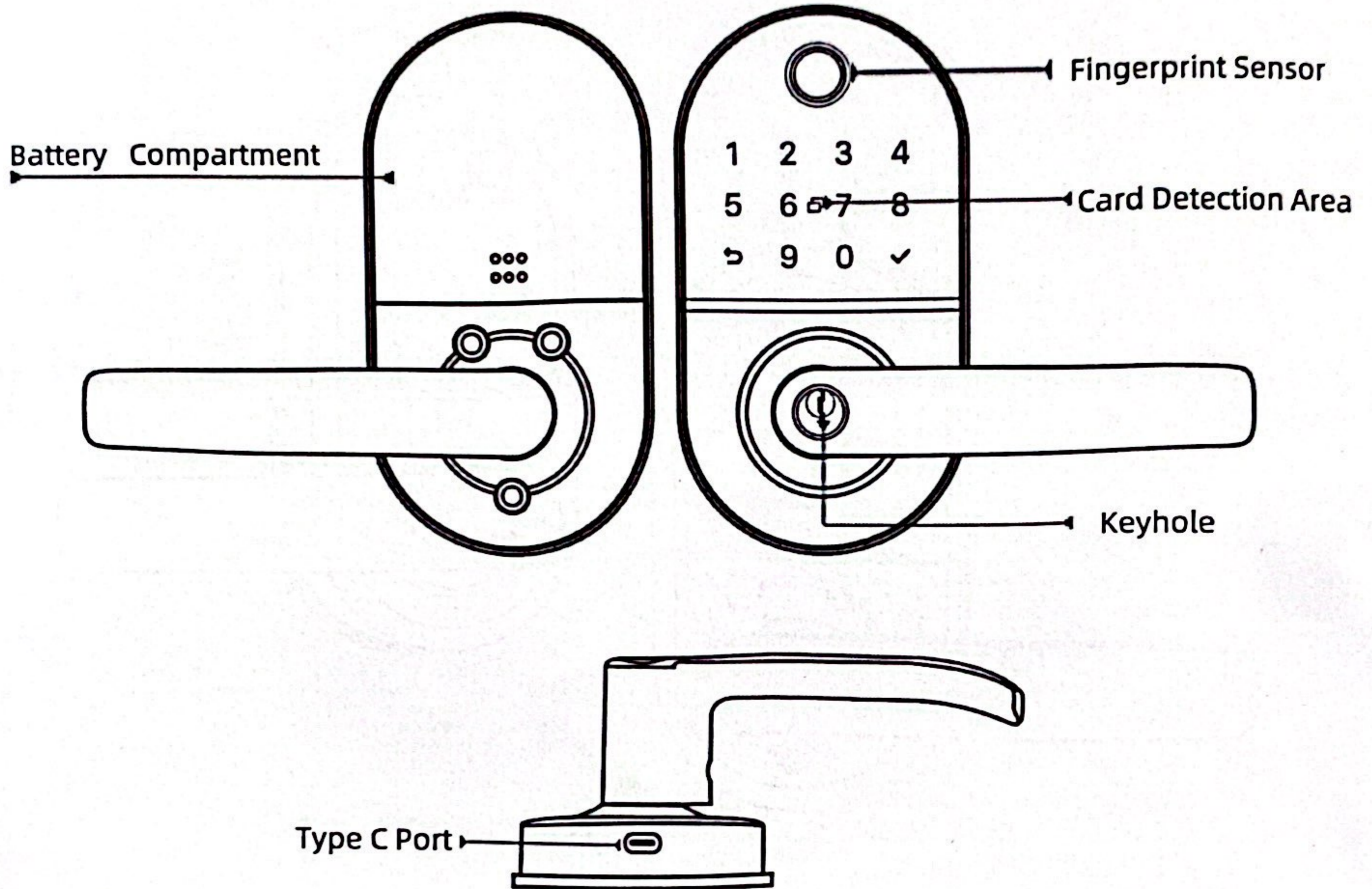

Fingerprint Sensor

Used to verify your finger and unlock from outside.

Card Detection Area

Swipe RFID card at this area.

Keyhole

Used to insert key to unlock in emergency situations.

Keypad

Used to enter the password and unlock from outside.

Battery Compartment

Install 4 AA Alkaline batteries.

Type C Port

Used to connect power bank to activate the lock when battery runs out.

(It can't charge the battery of lock)

2. Packing List

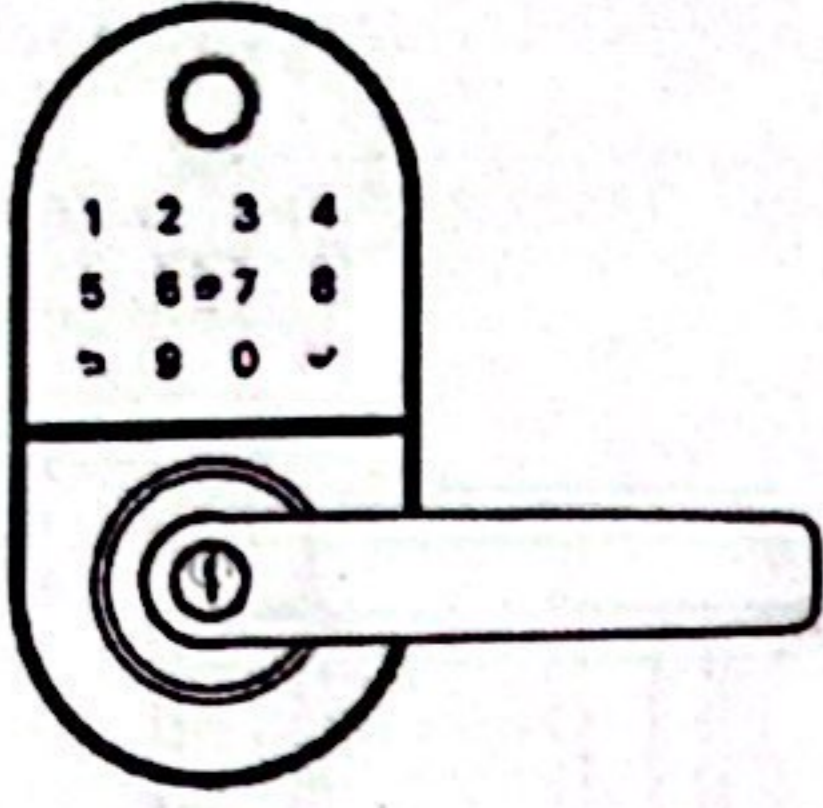

Exterior Assembly * 1

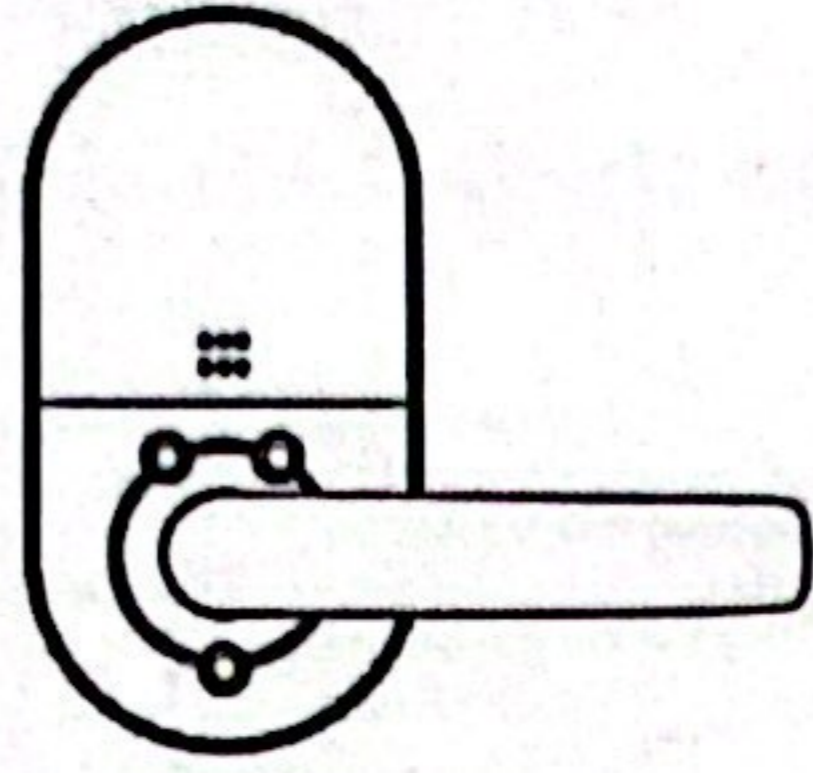

Interior Assembly * 1

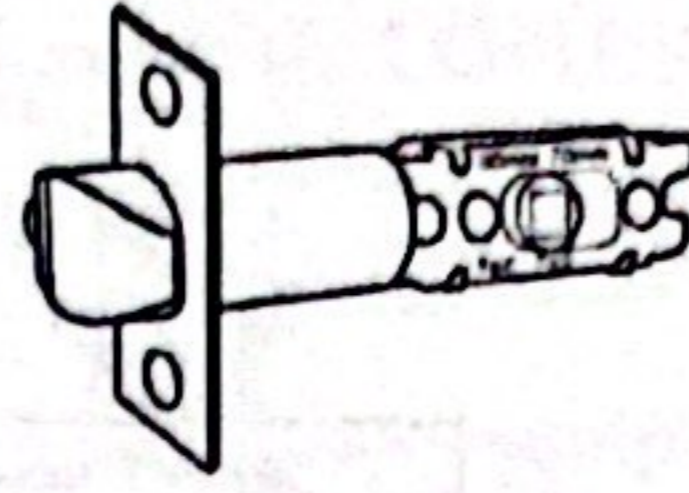

Latch*1



Rubber Plate * 2

Smart Lock User Manual
Model: 9113

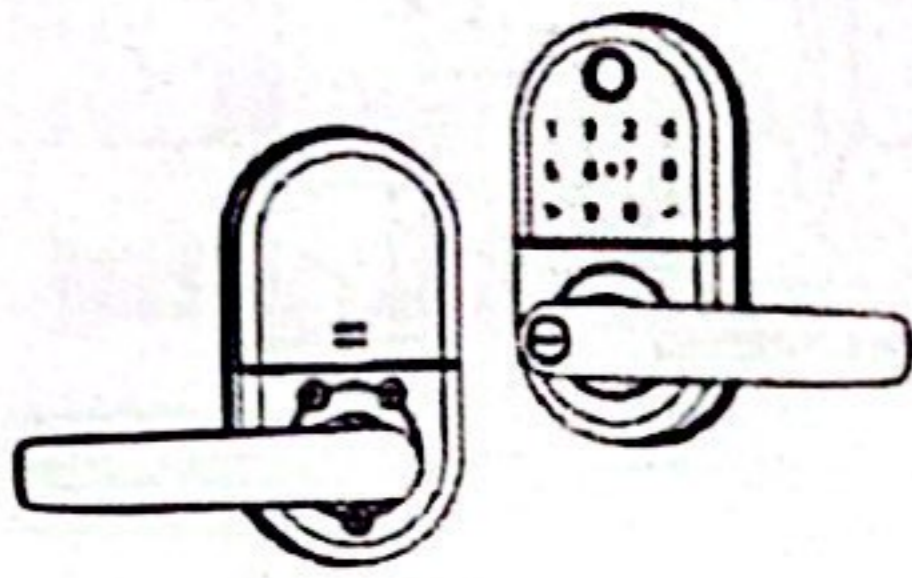

User Manual * 1

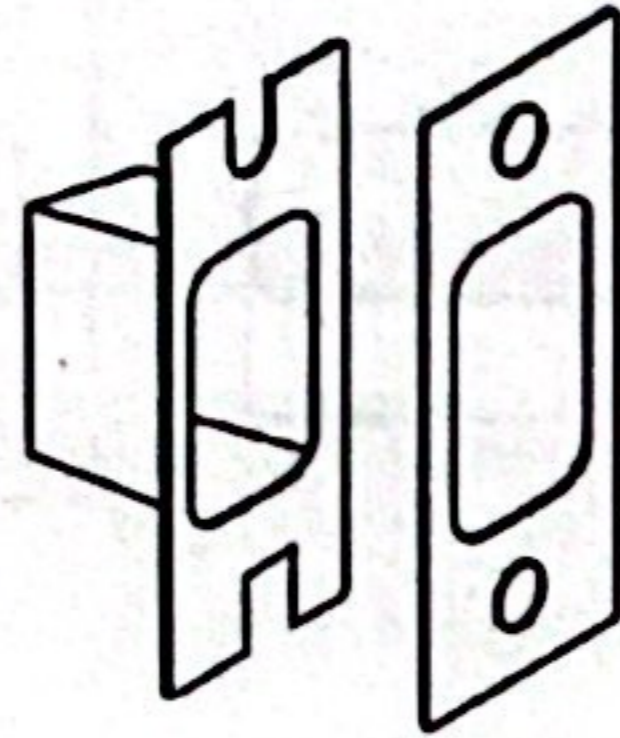

Strike & Strike Box * 1

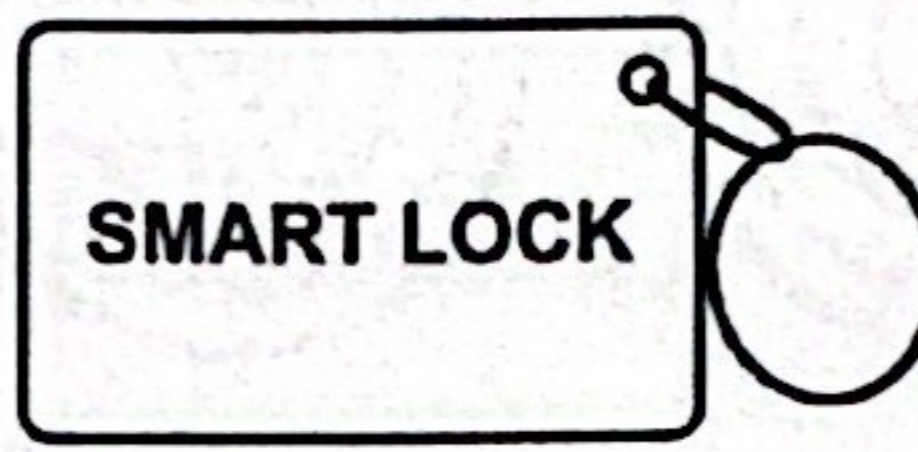

IC Card *

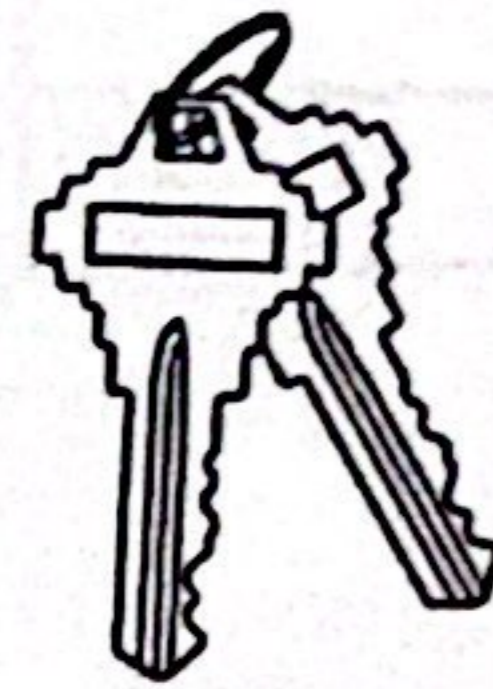

Mechanical Key* 2

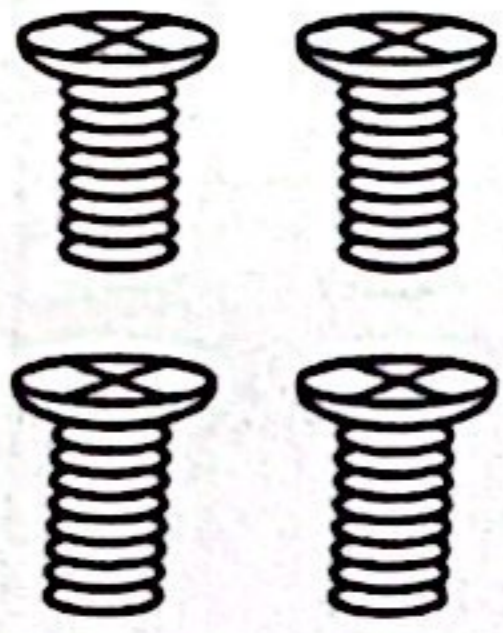

Screw A * 4



Pin*1



Screw B* 4



L Shape Allen Wrench * 1

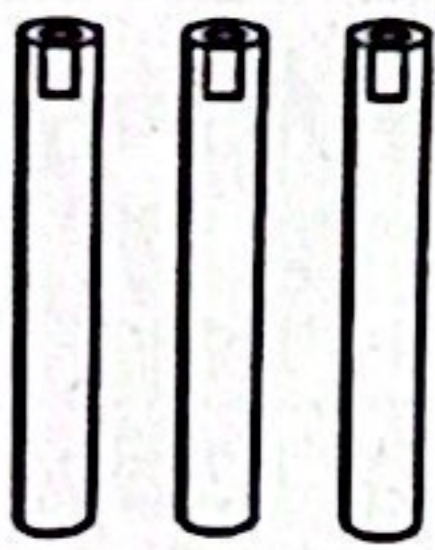

Screw stub A * 3



Screw C * 3

60 mm Square

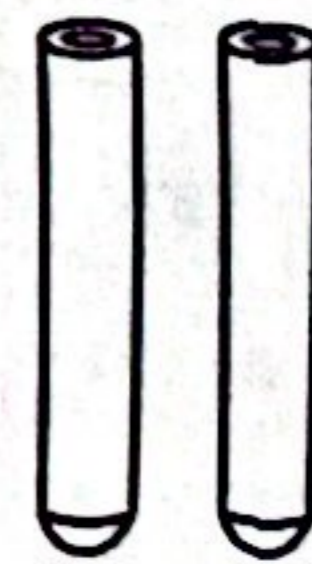

Positioning Column * 2

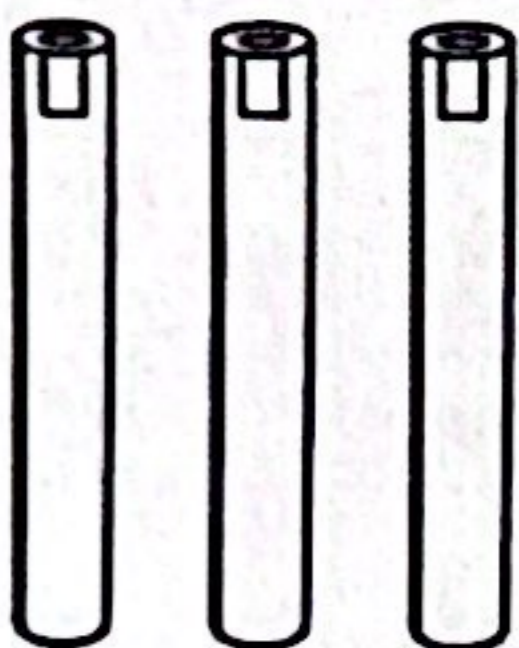

Screw stub A * 3

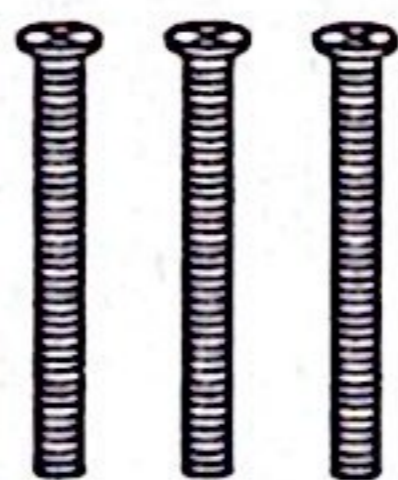

Screw D * 3

75 mm Square

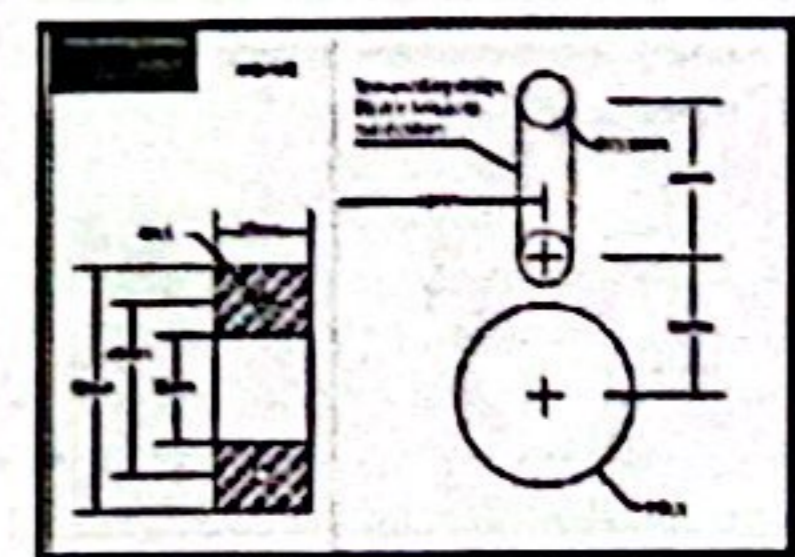

Punch Diagram

- Introduction
- Installation
- Operation
- P&A
- Accessories

3.Introduction

3.1.Lock structure

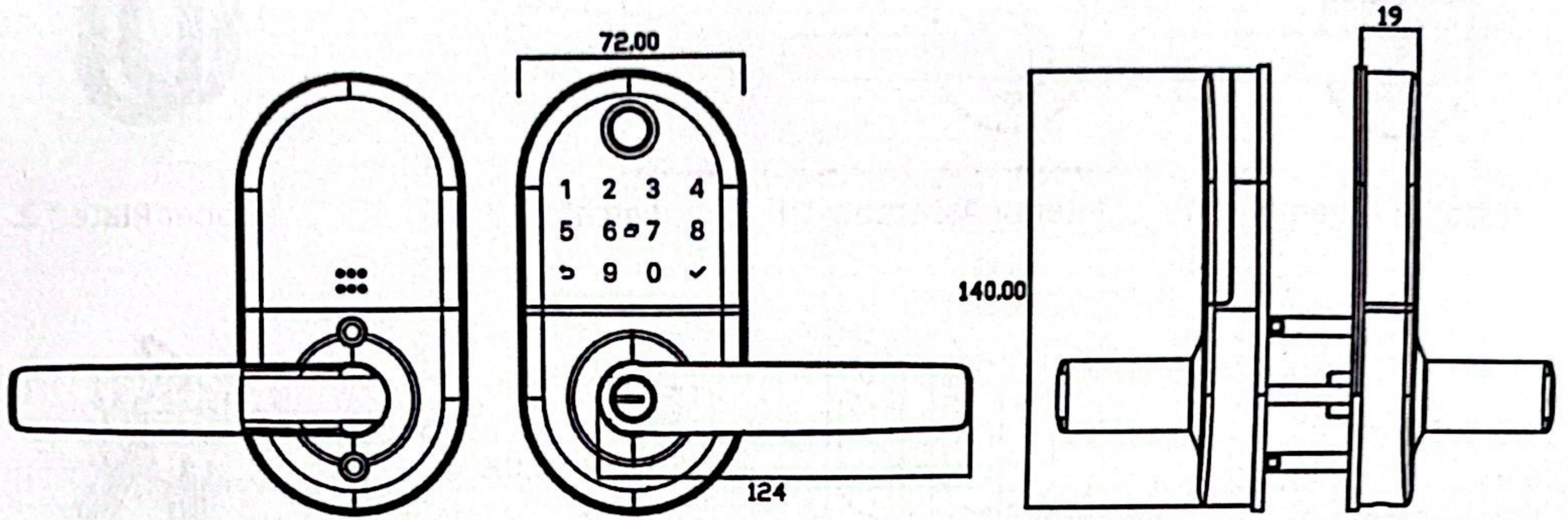

3.2.Specifications

Suitable for Models	H13-TB	Doors Applicable	Aluminum door Wooden door
Materials	Aluminum alloy	Working Voltage	6V/4x AA Batteries
Lock Weight	2KG	Door Thickness to Fit	35-65mm
Unlocking Way	Bluetooth Fingerprint(option) Password Card Mechanical key Gateway(option)	Data Capacity	Fingerprint: 200 Password: 150 Card: 200
Color	Silver Black	Working Temperature	-10°C-55°C
Low Wattage Alarm	Less than 4.8V	Working Humidity	0-95%

4. Installation

4.1 Adjust Latch Backset Length

Measure your door backset, then adjust to the corresponding latch length.

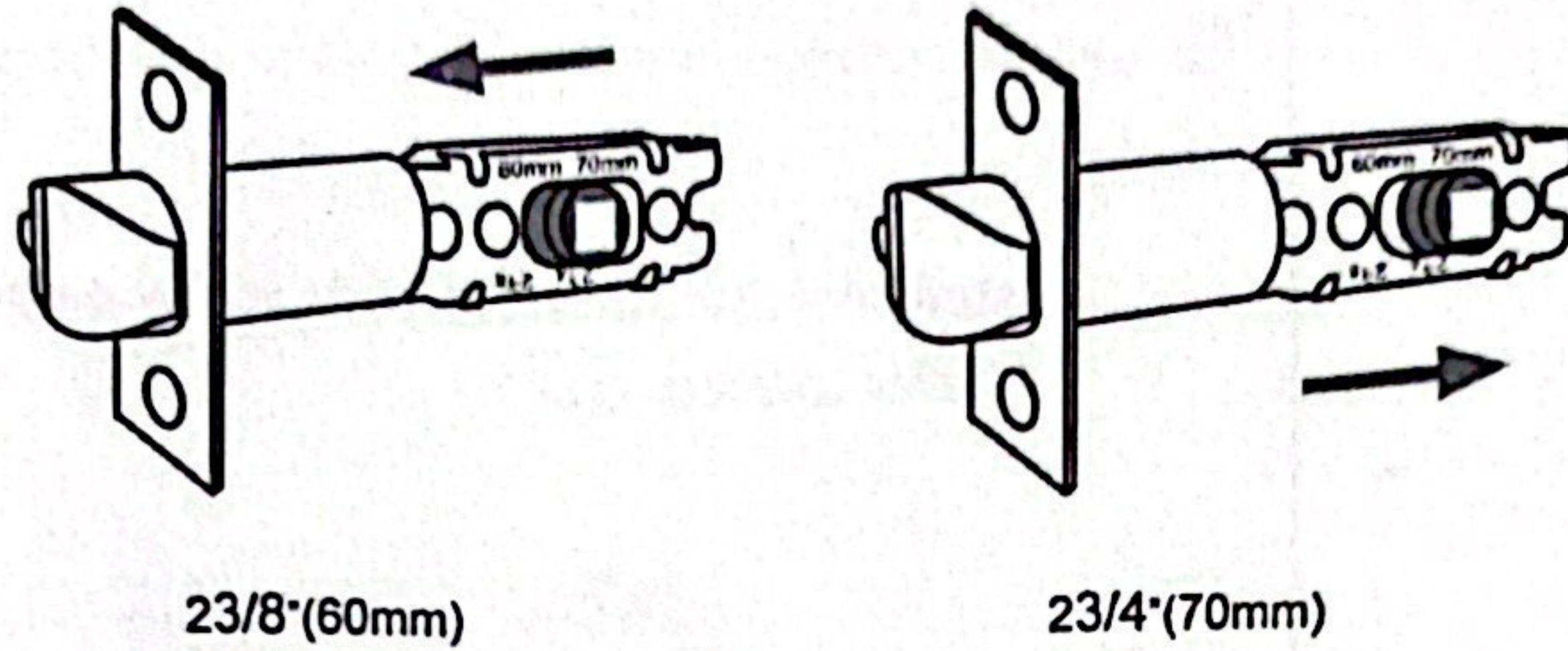

23/8" (60mm)

23/4" (70mm)

4.2 Adjust the Handles Direction

Notice: Adjust the handle according to the direction you open the door.

For Exterior Assembly:

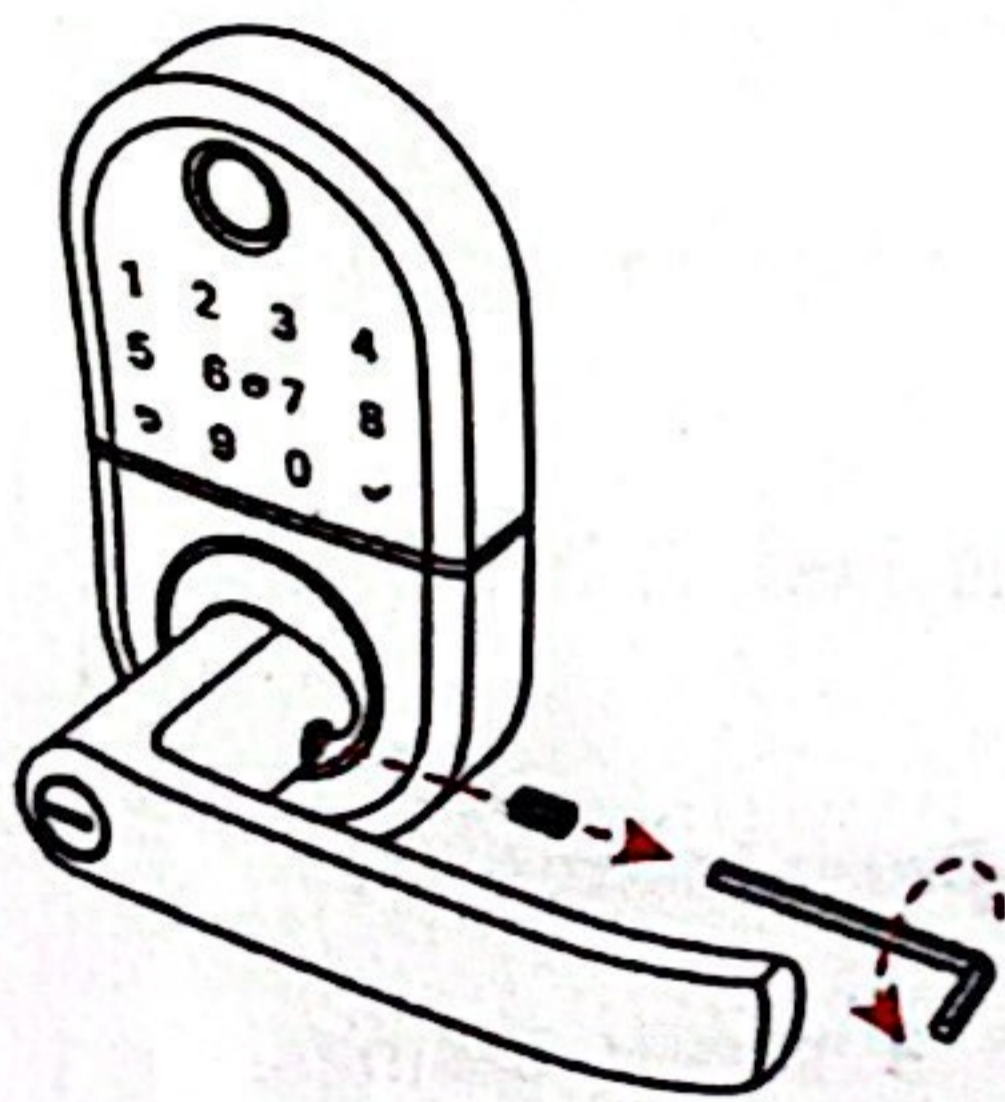

1. Loosen the screw with a 3mm Allen wrench

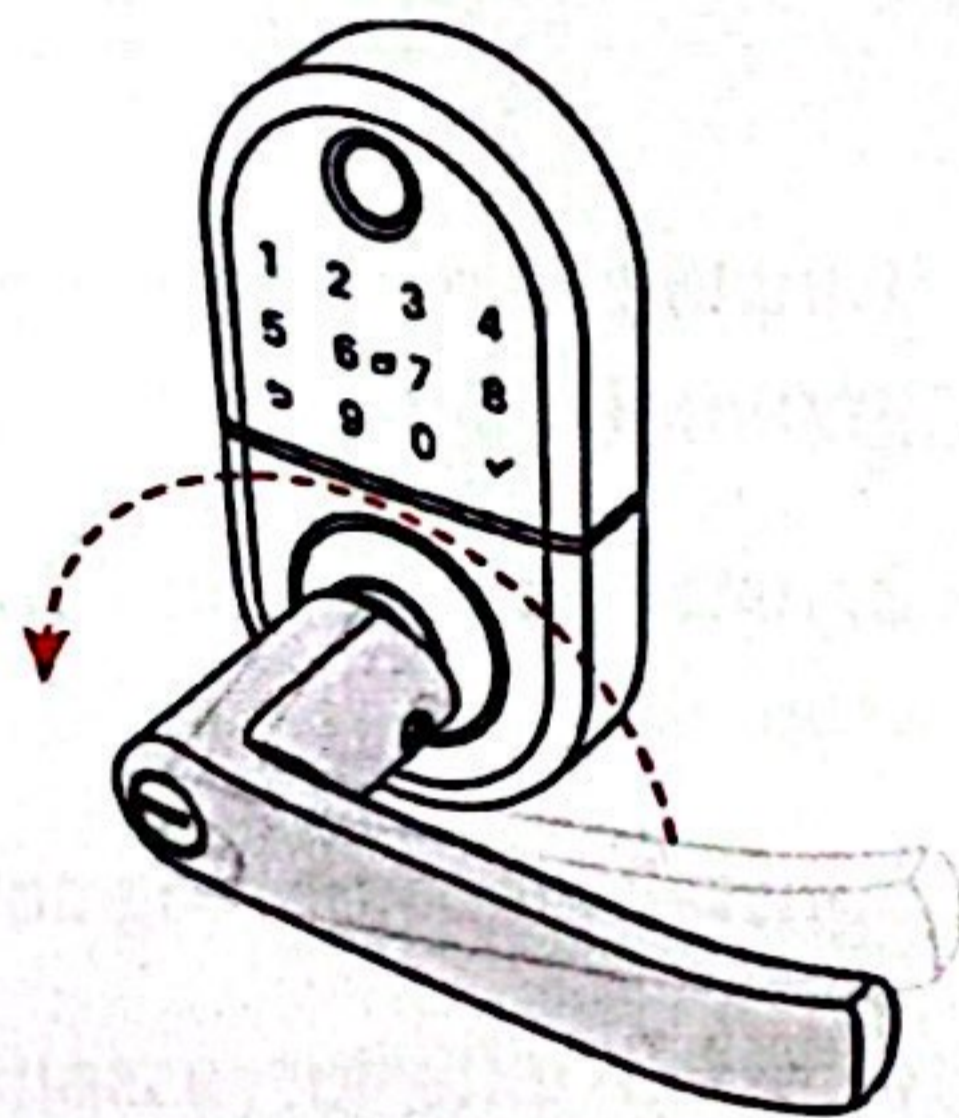

2. Adjust the door handle direction

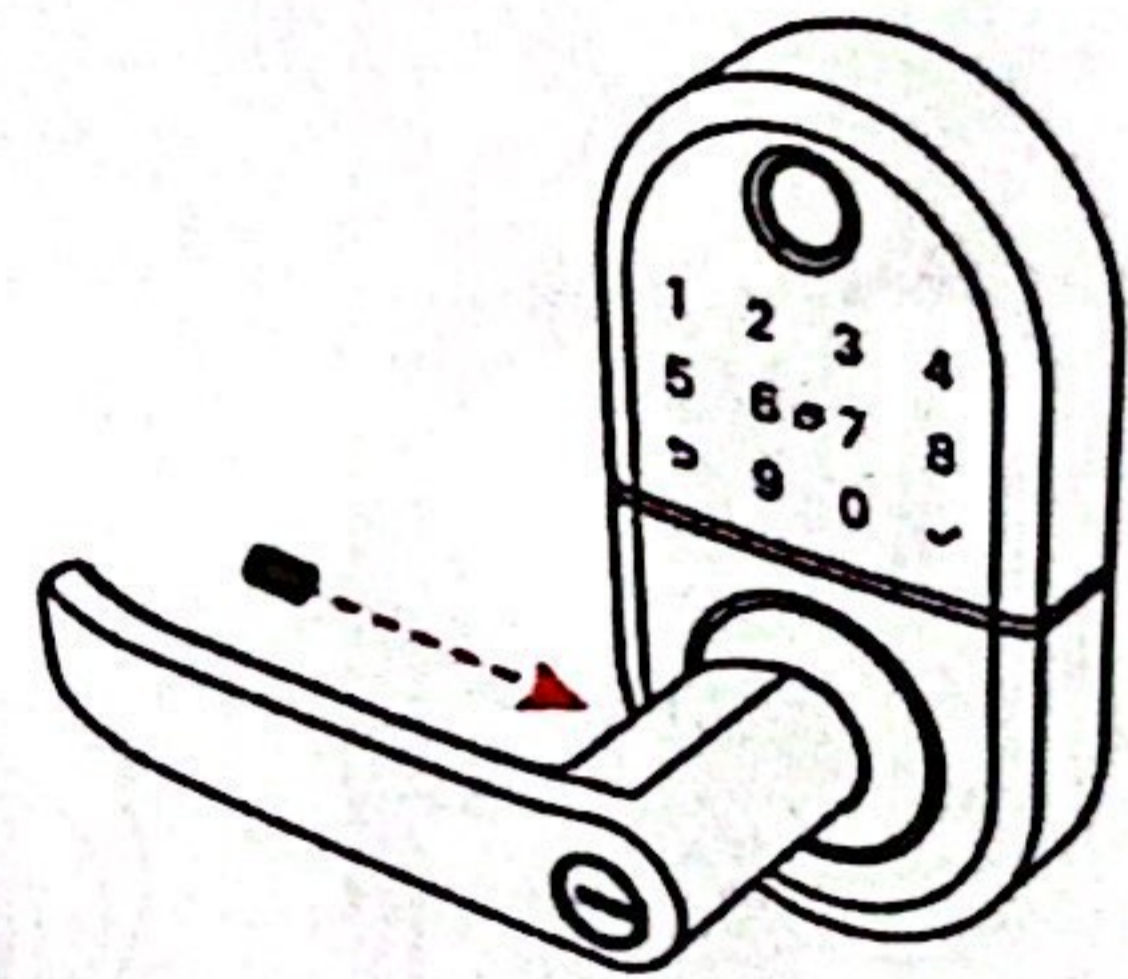

3. Tighten the screws after adjusting the handle direction and complete.

For Interior Assembly:

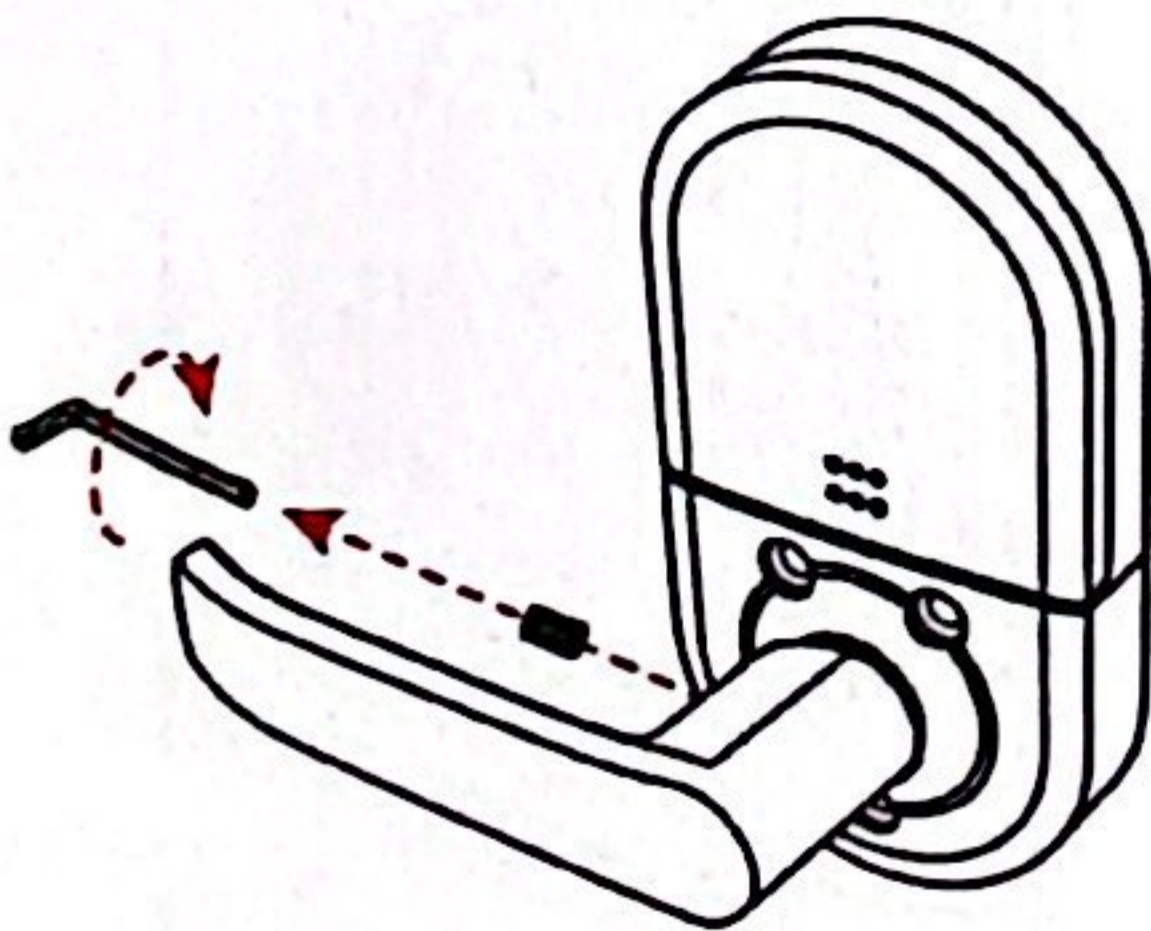

1. Loosen the screw

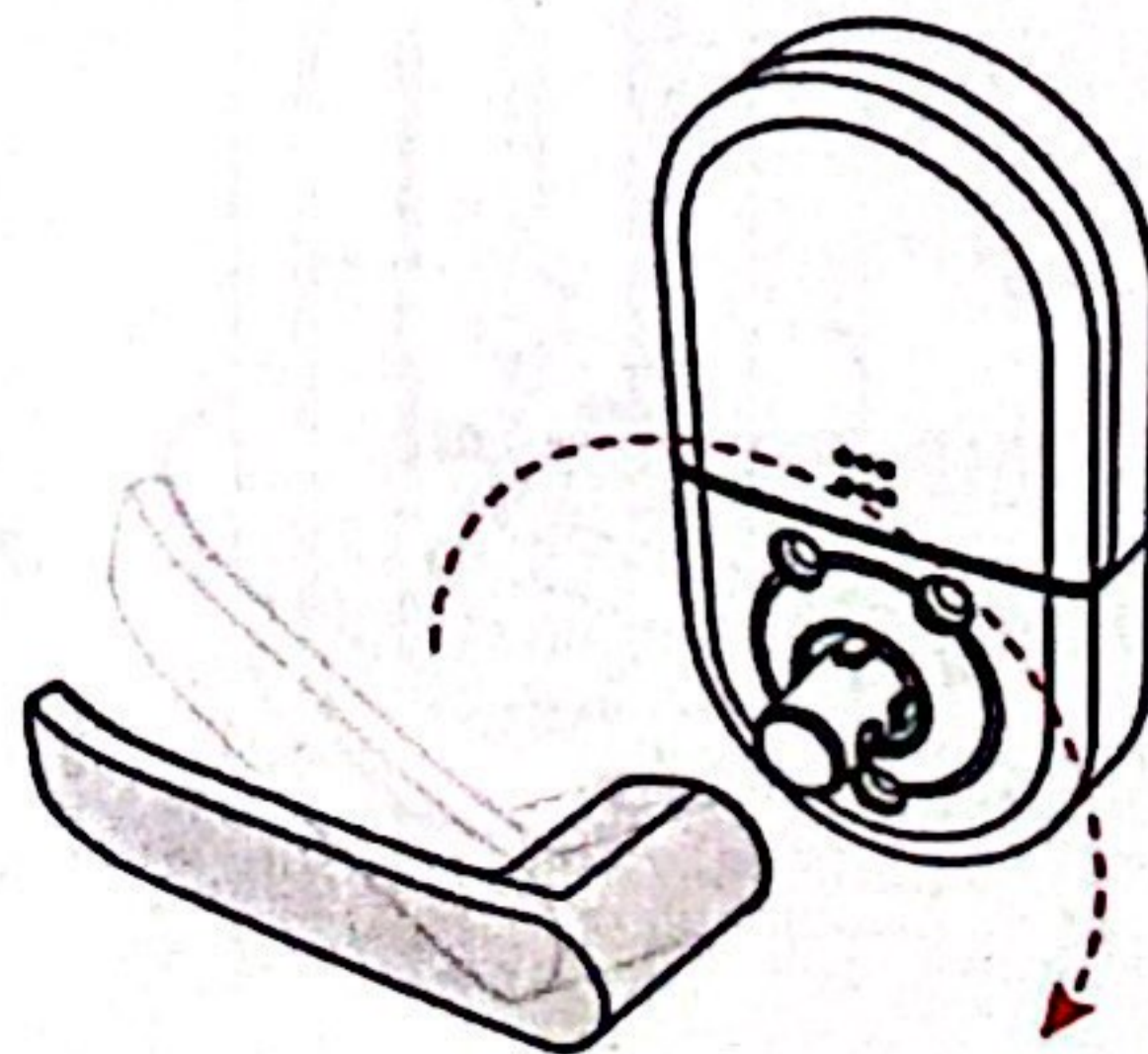

2. Adjust the door handle direction

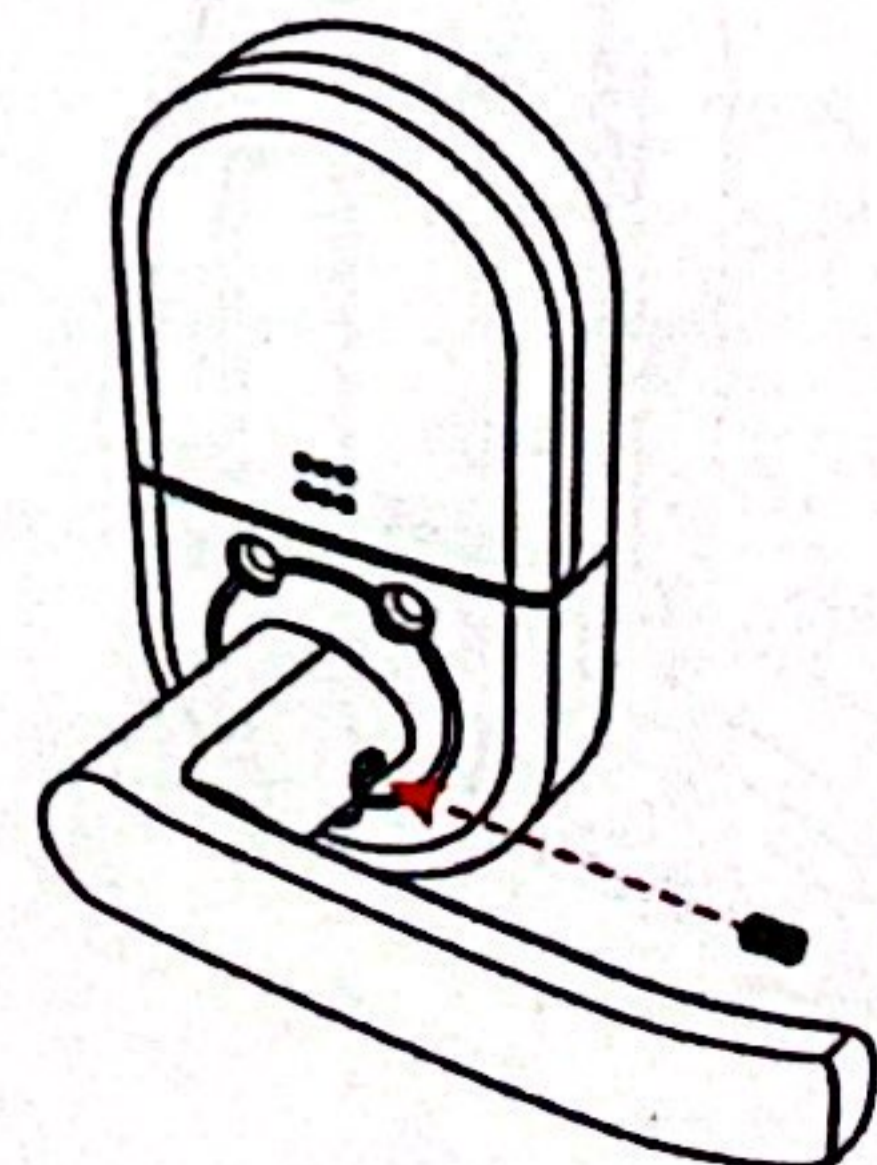

3. Tighten the screws after adjusting the handle direction and complete.

4.3. Installation Diagram

Step 1 Install Mortise

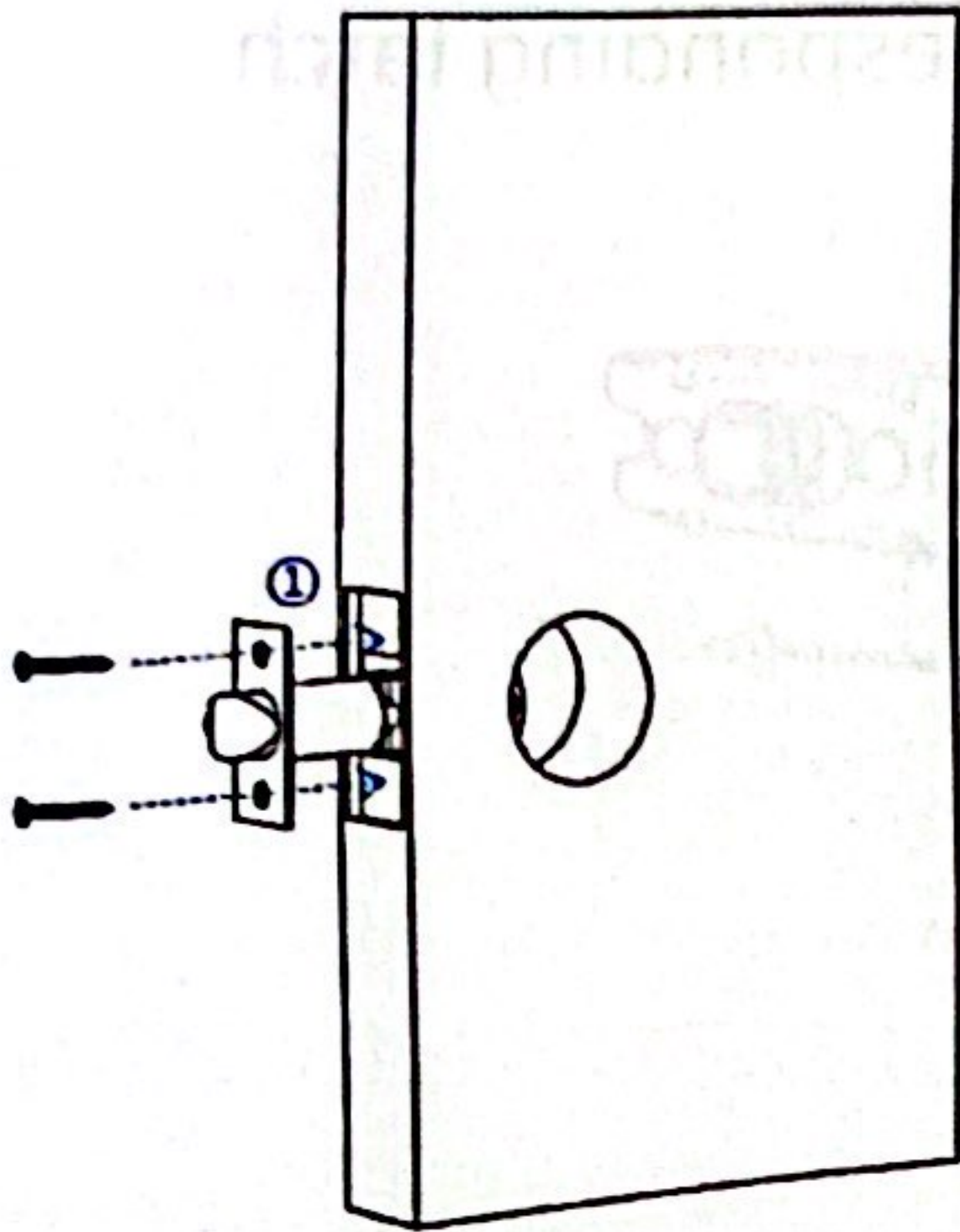

Install Mortise into door with Screw B and fix it.
(Refer to step ①)

Step 2 Install Exterior Assembly

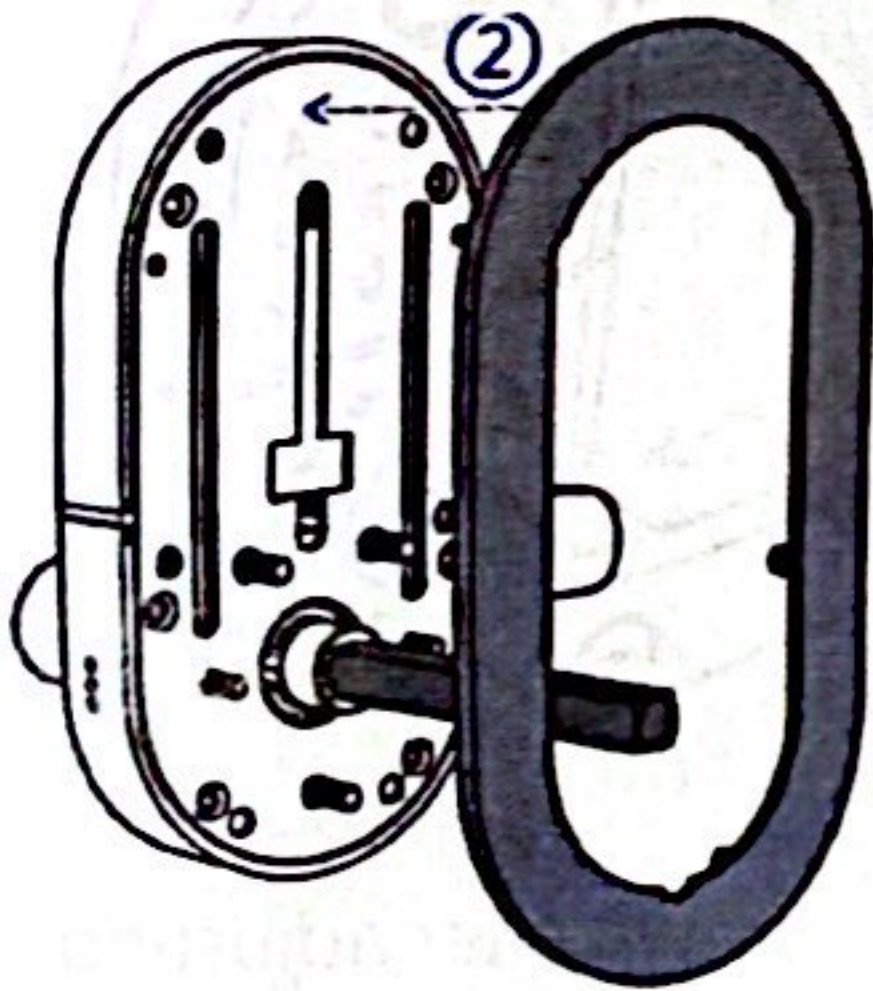

1. Install the waterproof rubber plate to exterior assembly. (Refer to step ②)

2. Install square shaft into spindle hub. (Refer to step ③)

3. Install 2 positioning columns. (Refer to step ④)

4. Install exterior assembly with 3 screw casings. (Refer to step ⑤)

5. Install exterior assembly.

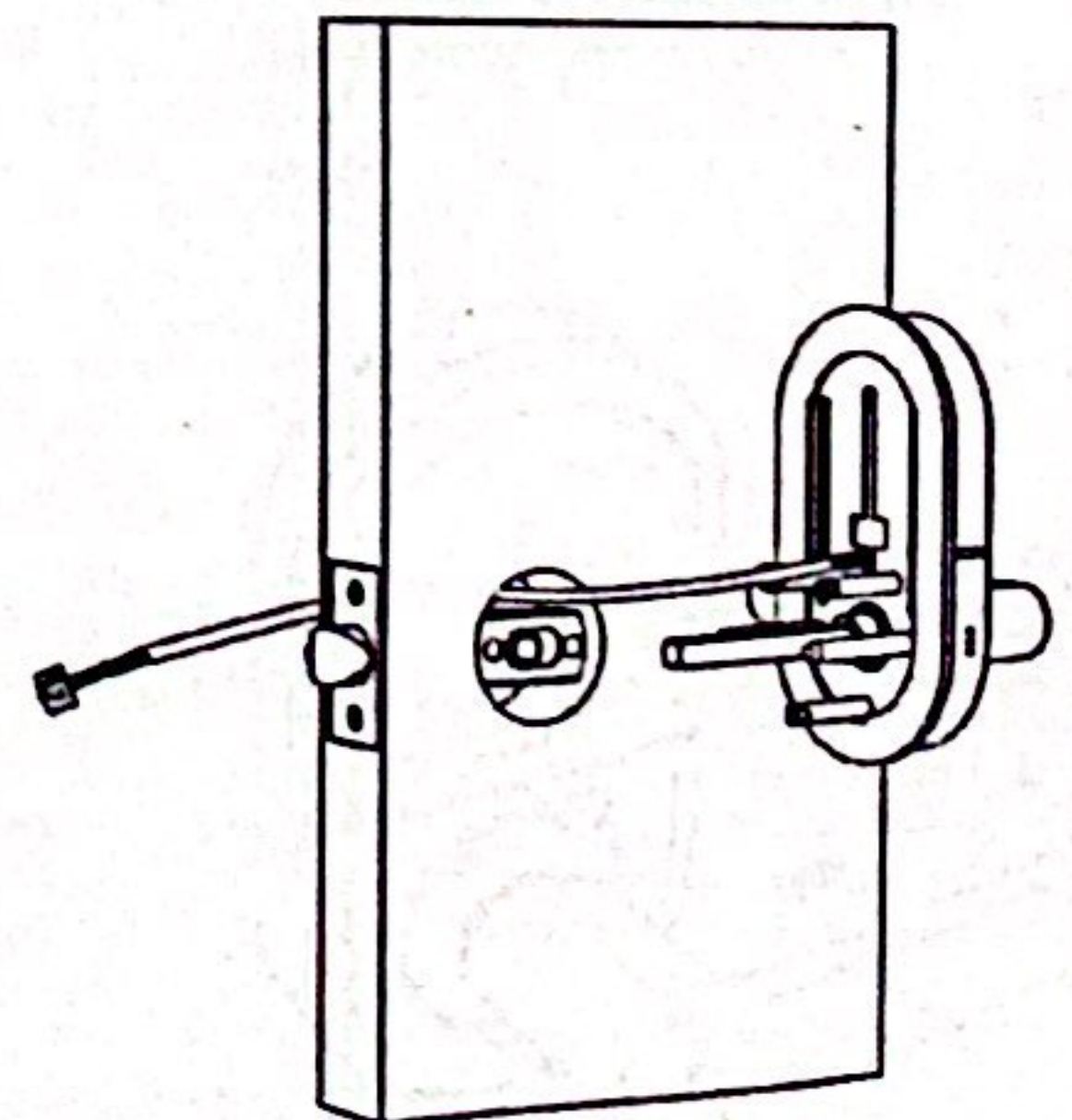
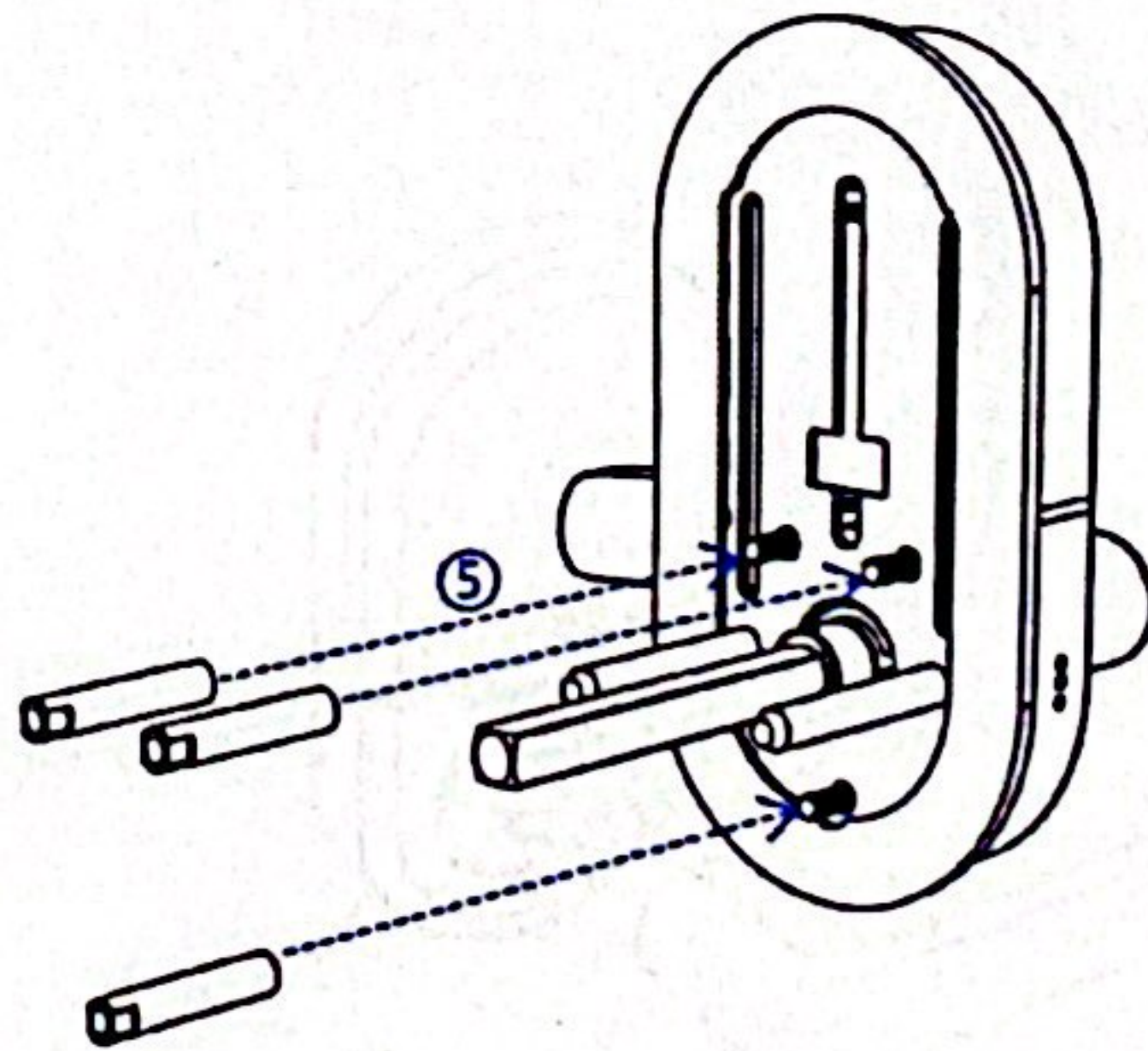
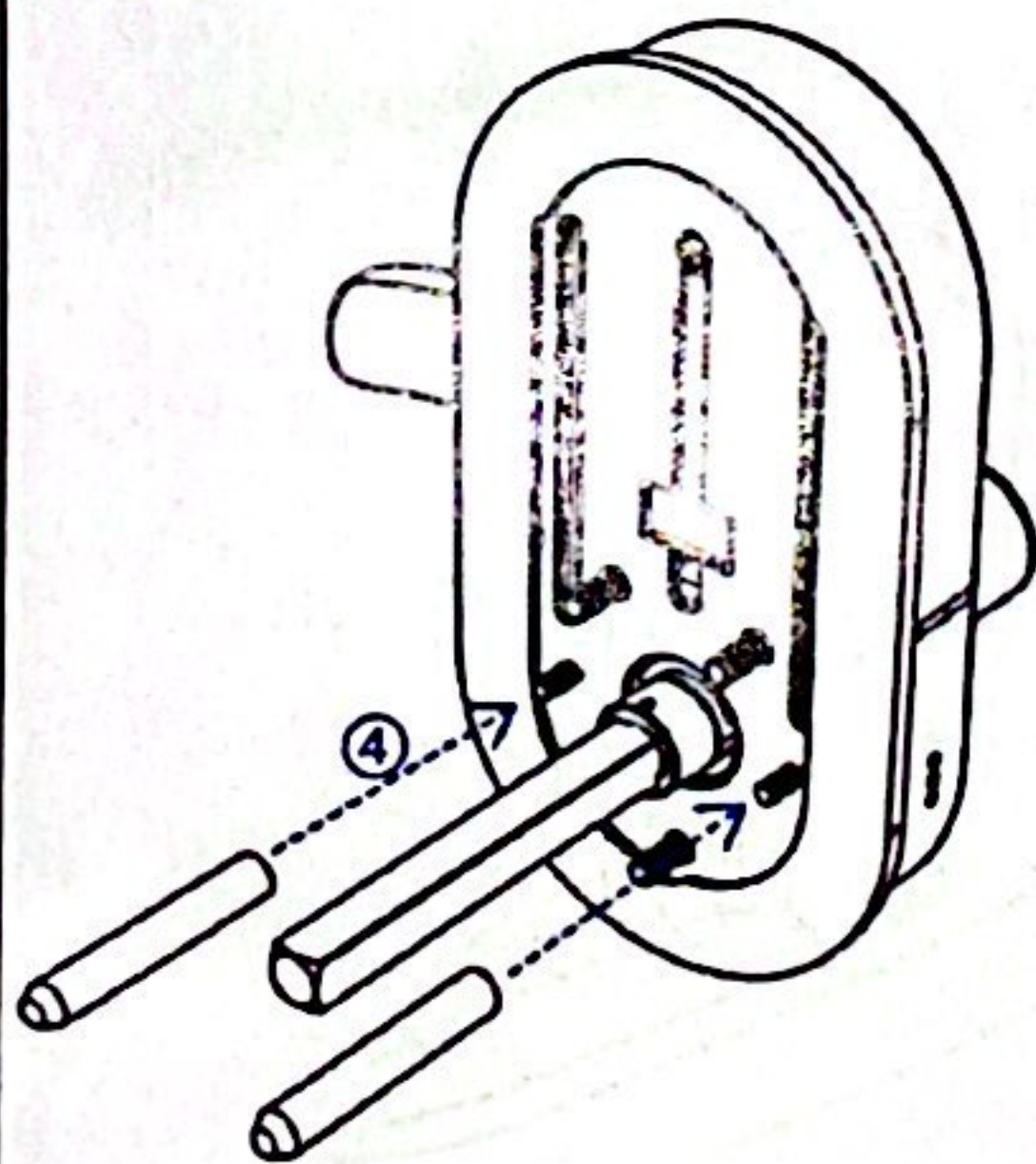

Step 3 Install Interior Assembly

1. Install the waterproof rubber plate. (Refer to step ⑥)
2. Connect the wire. (Refer to step 7)
3. Secure exterior assembly with screw C. (Refer to step ⑧)

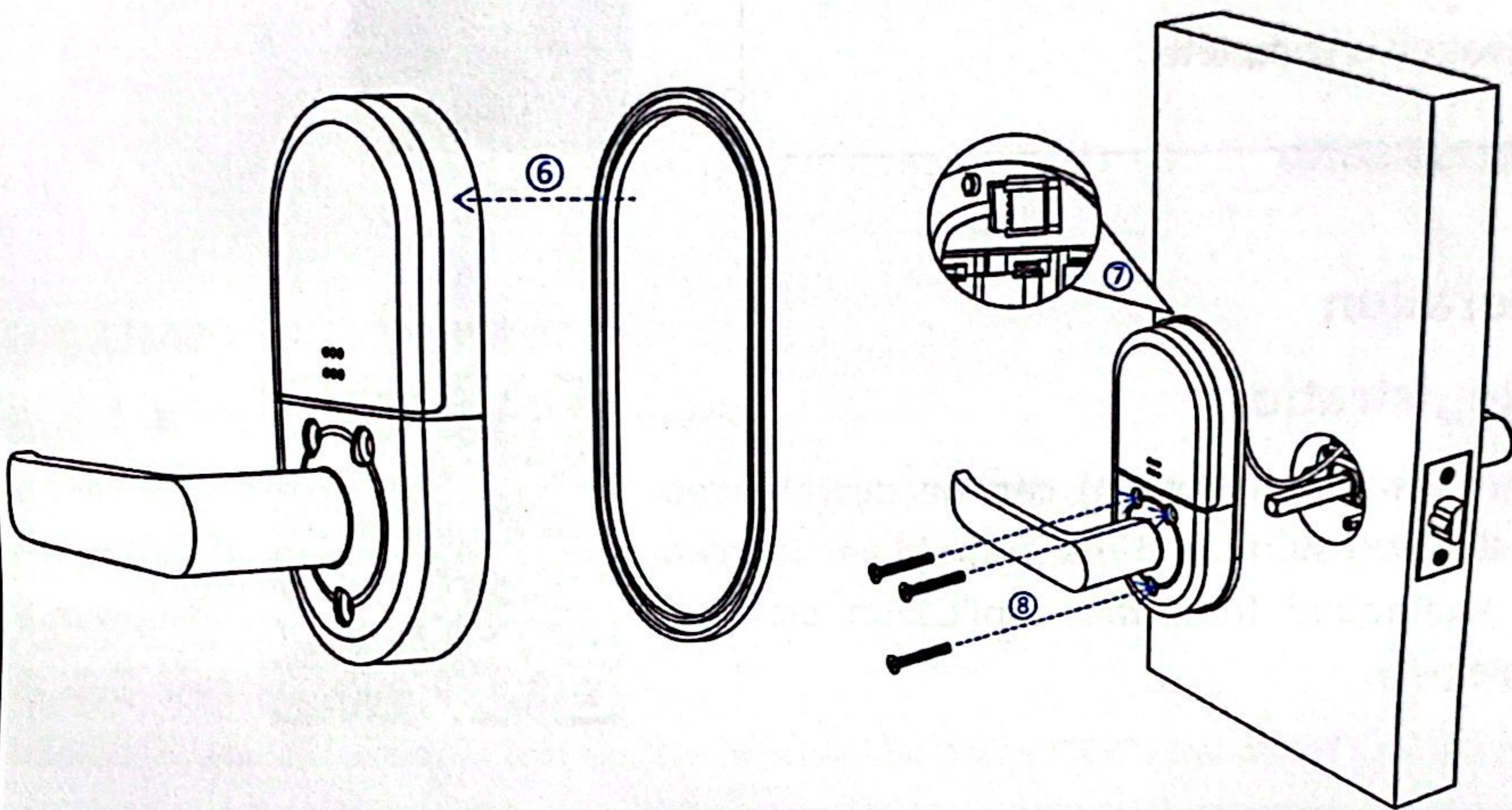

Step 4 Install batteries

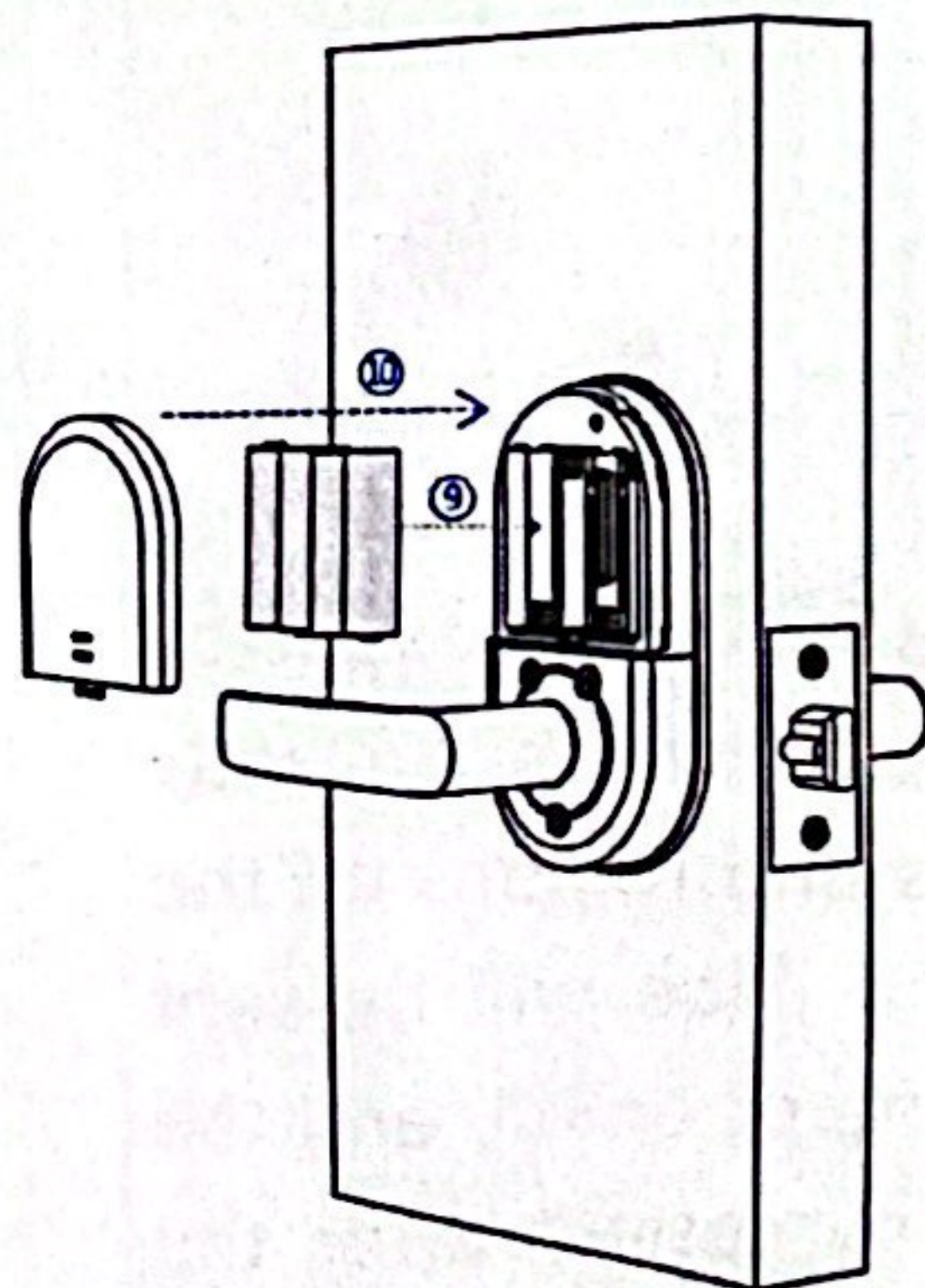

1. Insert 4 AA alkaline batteries. (Refer to step ⑨)
2. Install the battery cover. Refer to step ⑩)
3. Installation Complete.

5. System Initialization

Open the cover plate of the front panel ,long press the "Reset" button on the back panel for 5s, press "000#",and the initialization is complete .

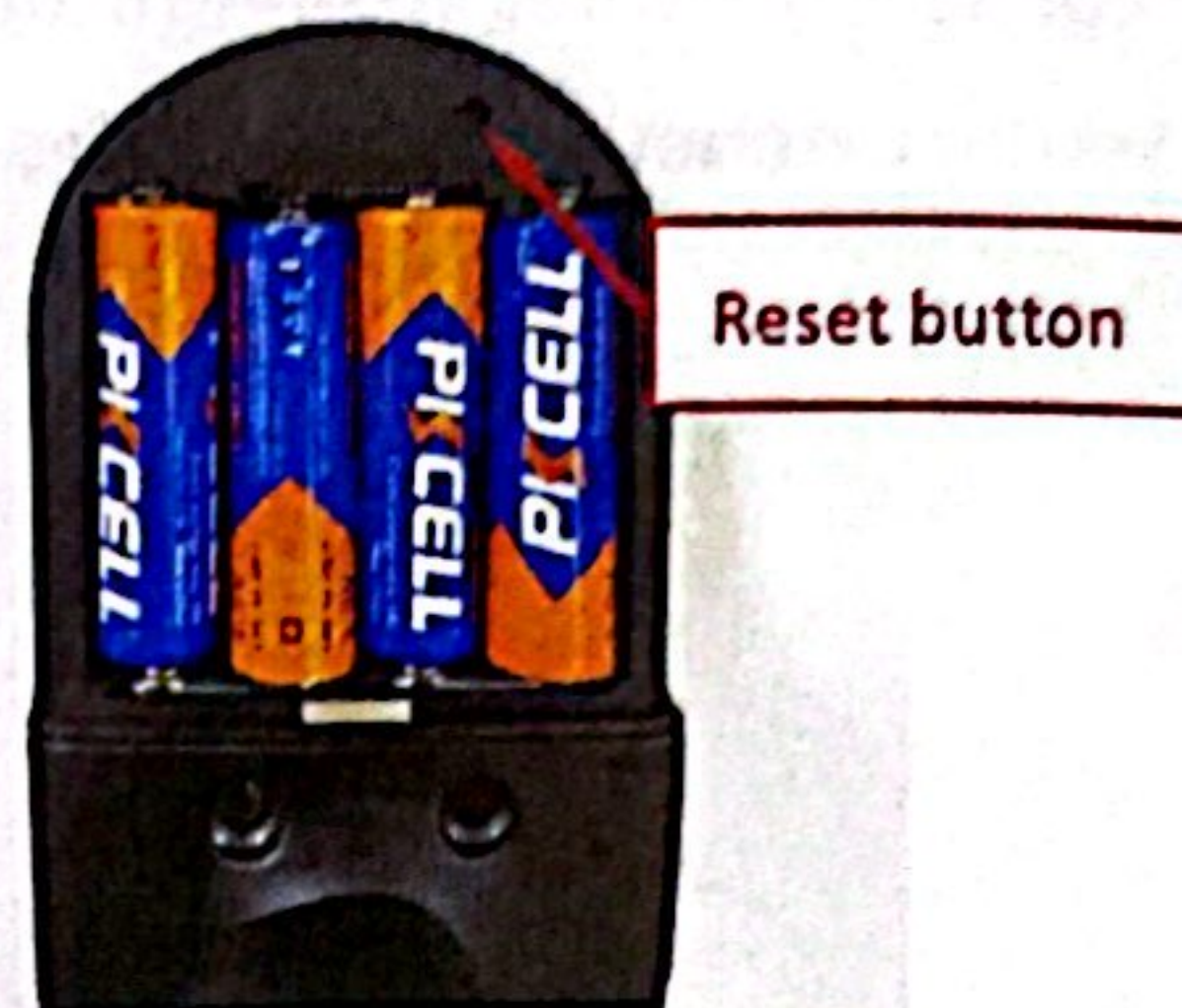

6. Operation

6.1. Registration

The software (iOS version) can be downloaded from the app store, and the Android version can be downloaded from the application store of Google play.



6.2. Connect lock to the phone

- 1) please scan the QR code to download the app
- 2) You can also search for TTlock in the APP store(Google Play)to download
- 3) Register a new account (phone number or email) or login with an existing account.
- 4) Touch the lock screen to light, click "+ Add Lock"
- 5) The lock nearby will appear on the phone screen, Click "+"
- 6) Re-name the lock
- 7) The lock added successfully

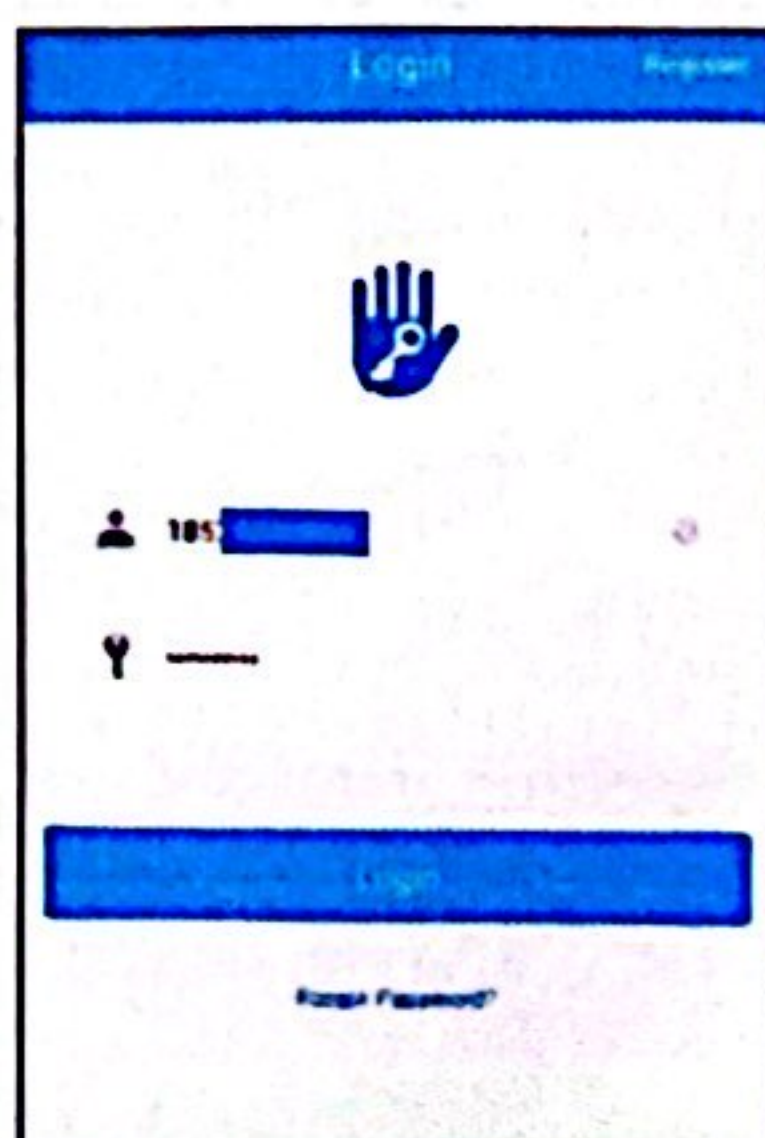
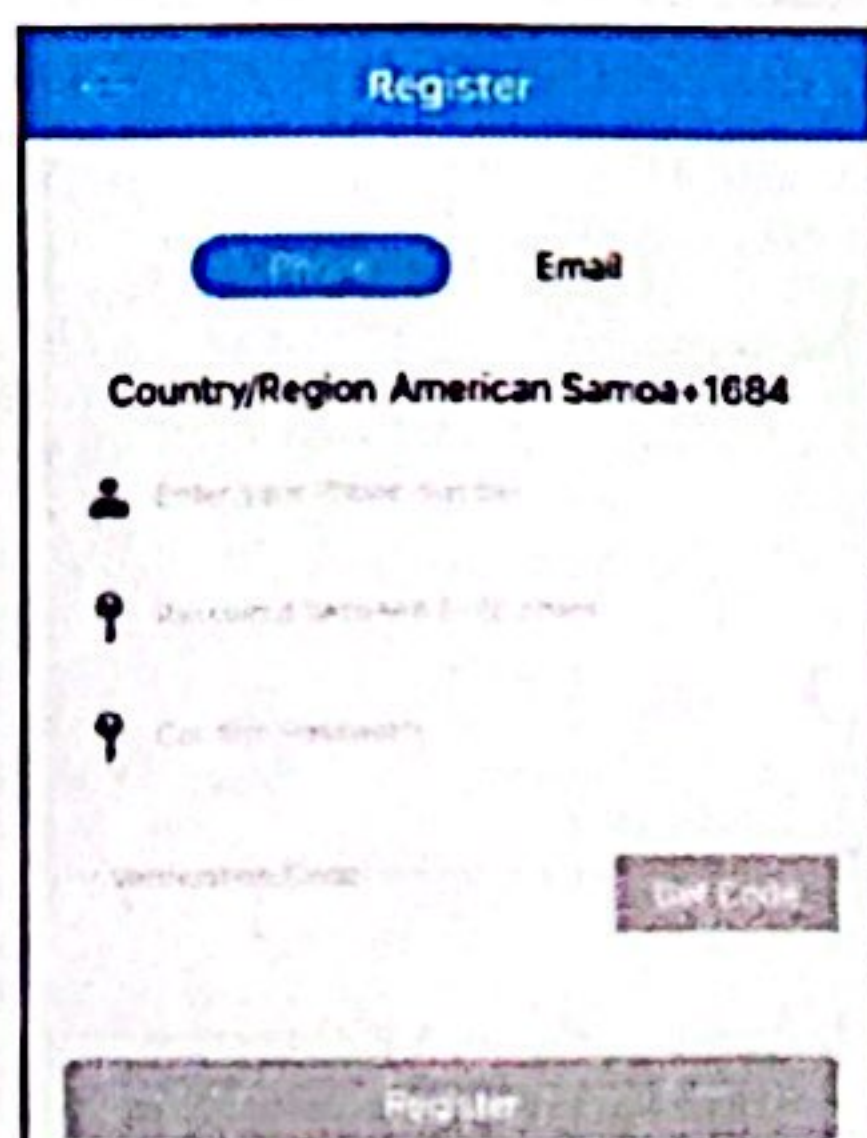

TTlock users can register the account by mobile phone and Email which currently support 200 countries and regions on the world. The verification code will be sent to user's mobile phone or email, and the registration will be successful after the verification.

5. System Initialization

Open the cover plate of the front panel ,long press the "Reset" button on the back panel for 5s, press "000#",and the initialization is complete .

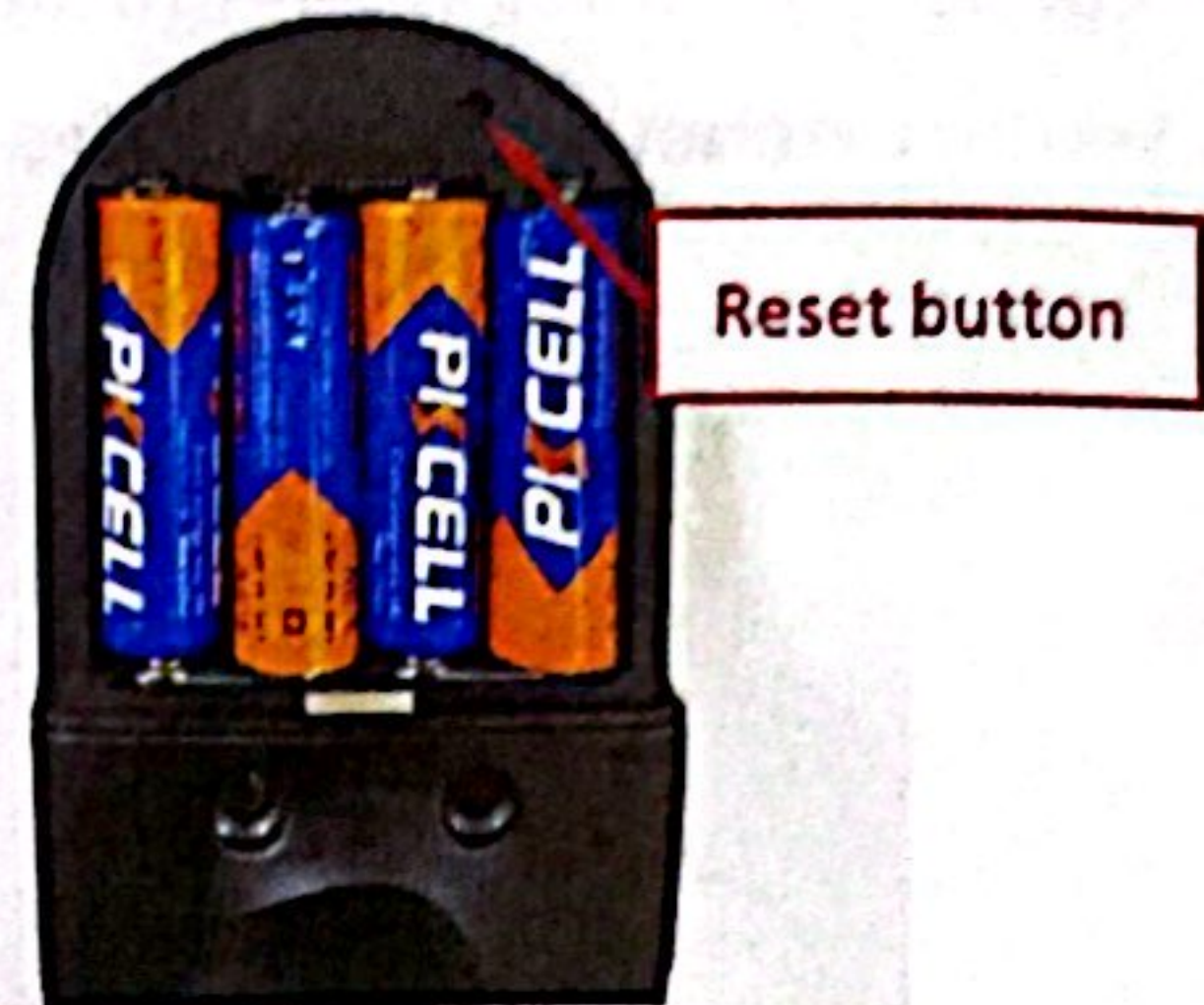

6. Operation

6.1. Registration

The software (iOS version) can be downloaded from the app store, and the Android version can be downloaded from the application store of Google play.



6.2. Connect lock to the phone

- 1) please scan the QR code to download the app
- 2) You can also search for TTlock in the APP store(Google Play)to download
- 3) Register a new account (phone number or email) or login with an existing account.
- 4) Touch the lock screen to light, click "+ Add Lock"
- 5) The lock nearby will appear on the phone screen, Click "+"
- 6) Re-name the lock
- 7) The lock added successfully

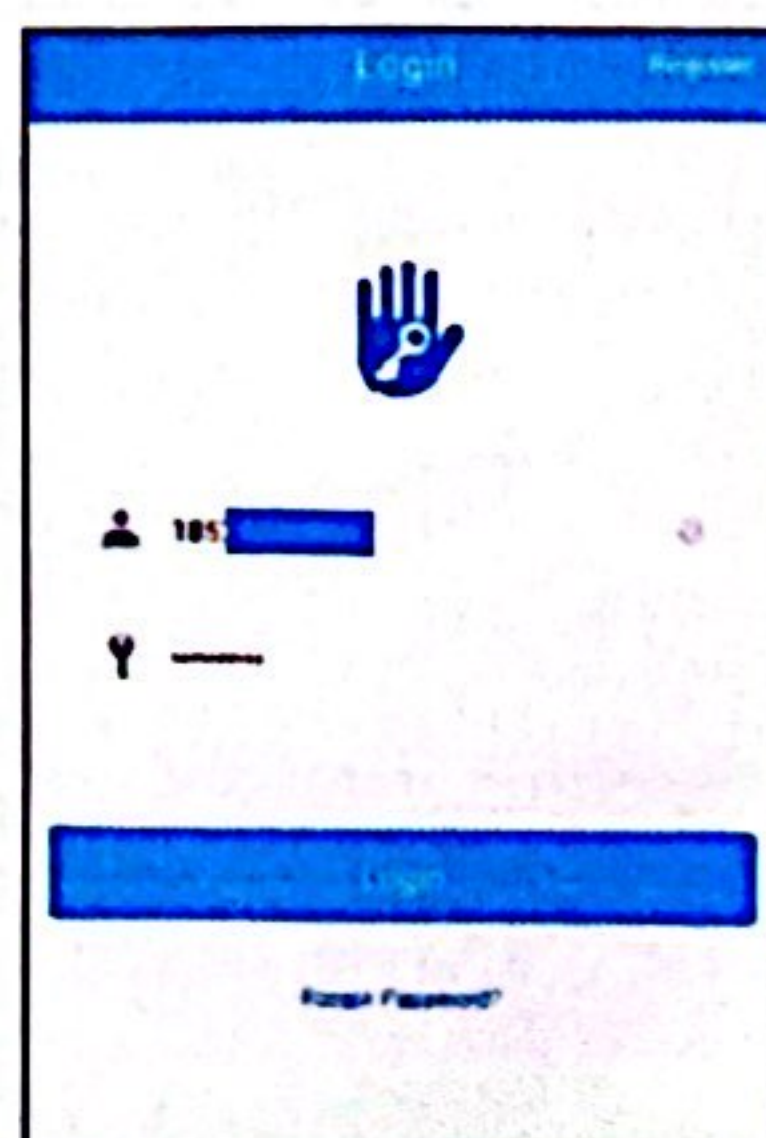
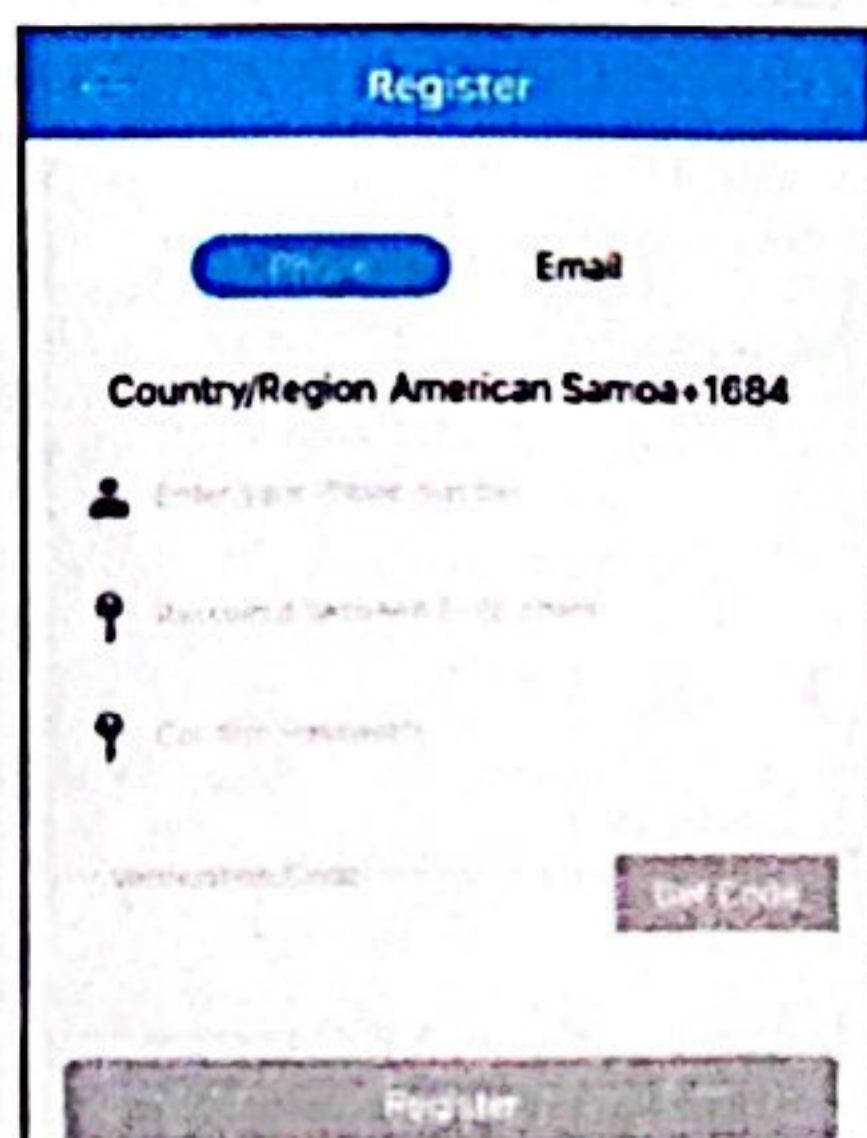

TTlock users can register the account by mobile phone and Email which currently support 200 countries and regions on the world. The verification code will be sent to user's mobile phone or email, and the registration will be successful after the verification.

6.3. Add locks

TTLock supports multiple types of lock devices. The lock needs to be added by the app after entering the add mode. Generally, a lock that has not been added, as long as the lock keyboard is touched, it will enter the add mode. The default password is 123456 if not added by the phone.

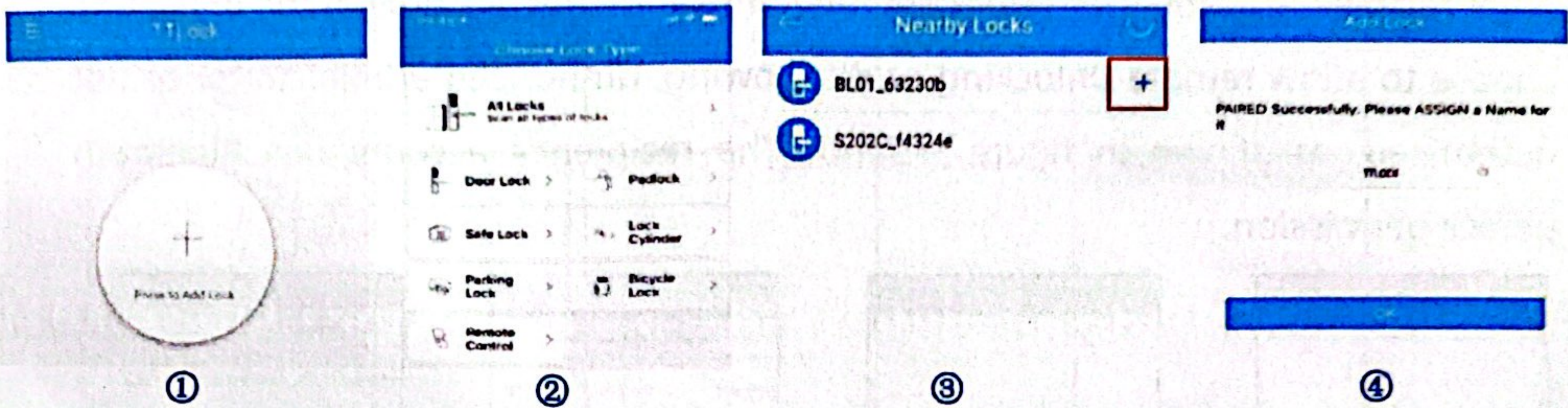

6.4. User Management

6.4.1. Bluetooth management

Make sure there is no problem with Bluetooth communication. After connecting the phone to the door lock as above, Click "  "to unlock.(the phone is within 5meters from the door lock)

6.4.2. Setting Passcode

Passcodes are also a way to unlock. After entering the passcode on the locked keyboard, press the unlock button in the lower right corner to unlock. Passcodes are divided into permanent, timed, one-time, custom, recurring, and erase.(You can share the Passcode to other user via SMS, Email, Messenger, Whatsapp)

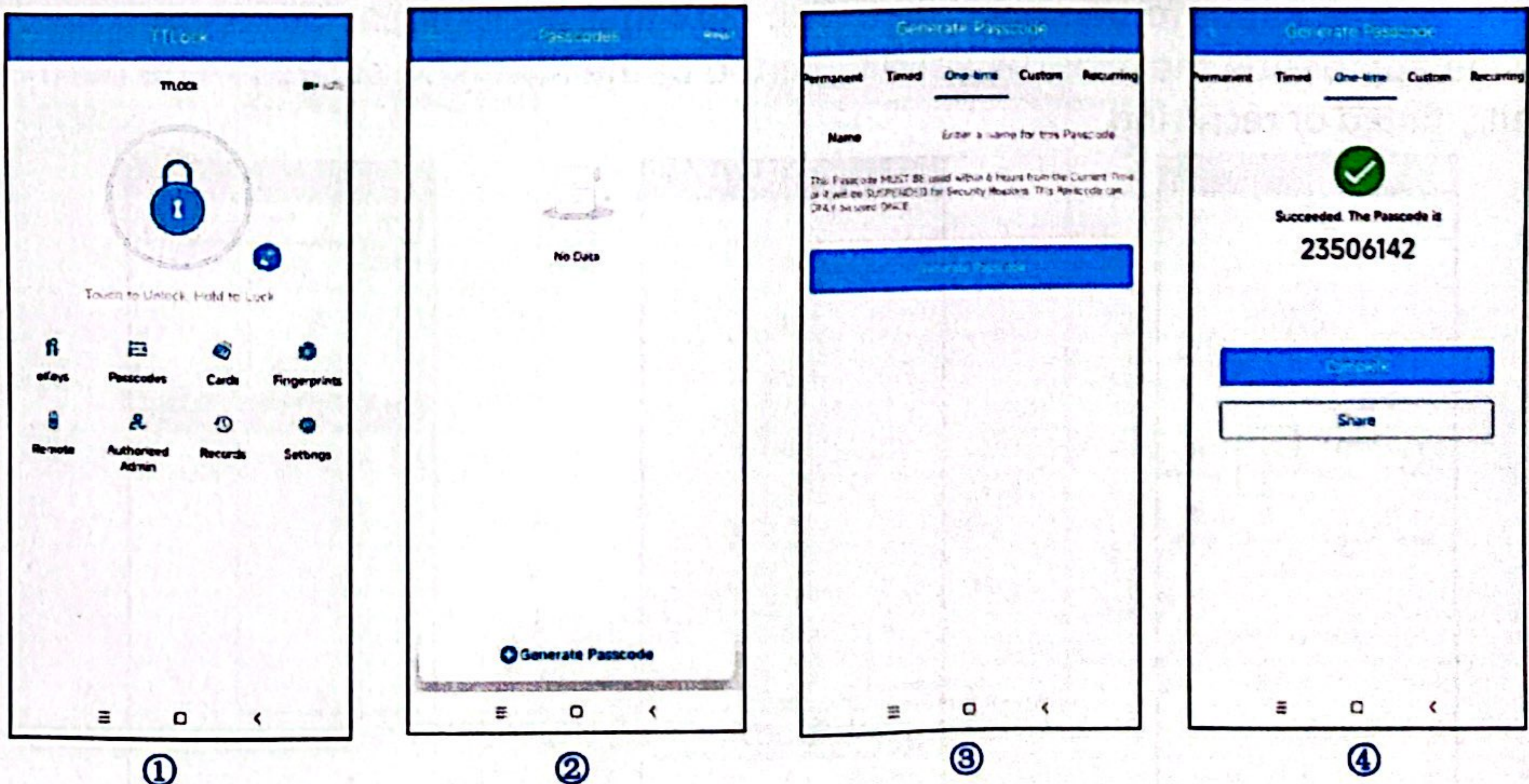

6.4.3. Send e-Key

Click on the "  " as shown in figure, you can send the eKey to other users of TTlock to authorize the unlock (the receiver must be download the APP and set up an account) → Select e-key format (Timed, permanent, One-time, Recurring) → Enter recipient's account of TTlock, set the name and effective time of the eKey, Can choose to allow remote unlocking or disallowing, authorized administrator or not authorized, as shown in figure → Send → The recipient's account has Bluetooth unlock permission.

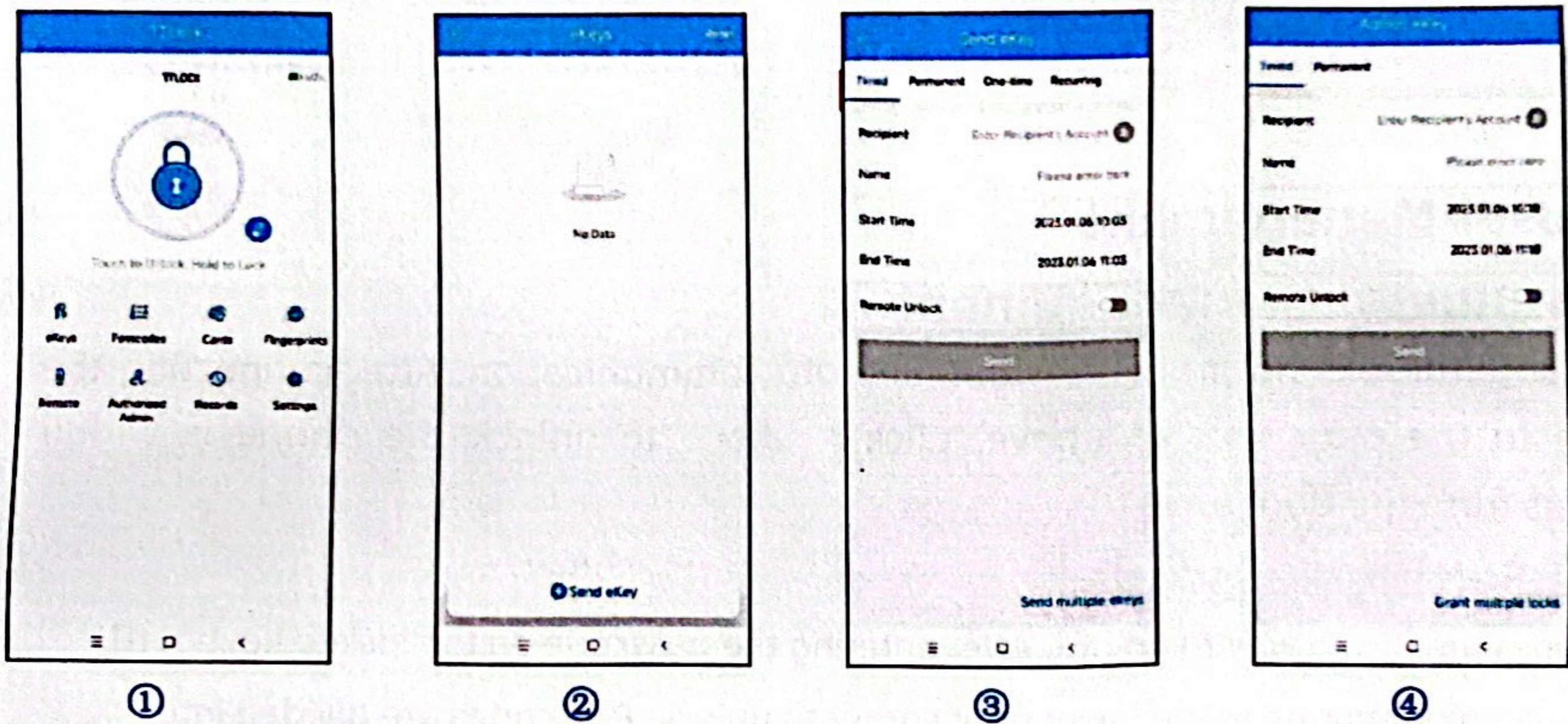

6.4.4. Add card

Supports opening doors through various IC cards. Before an IC card is used to open the door, it needs to be added first. The adding process needs to be performed by the app beside the lock. The validity period of the IC can be set, it can be permanent, timed or recurring.

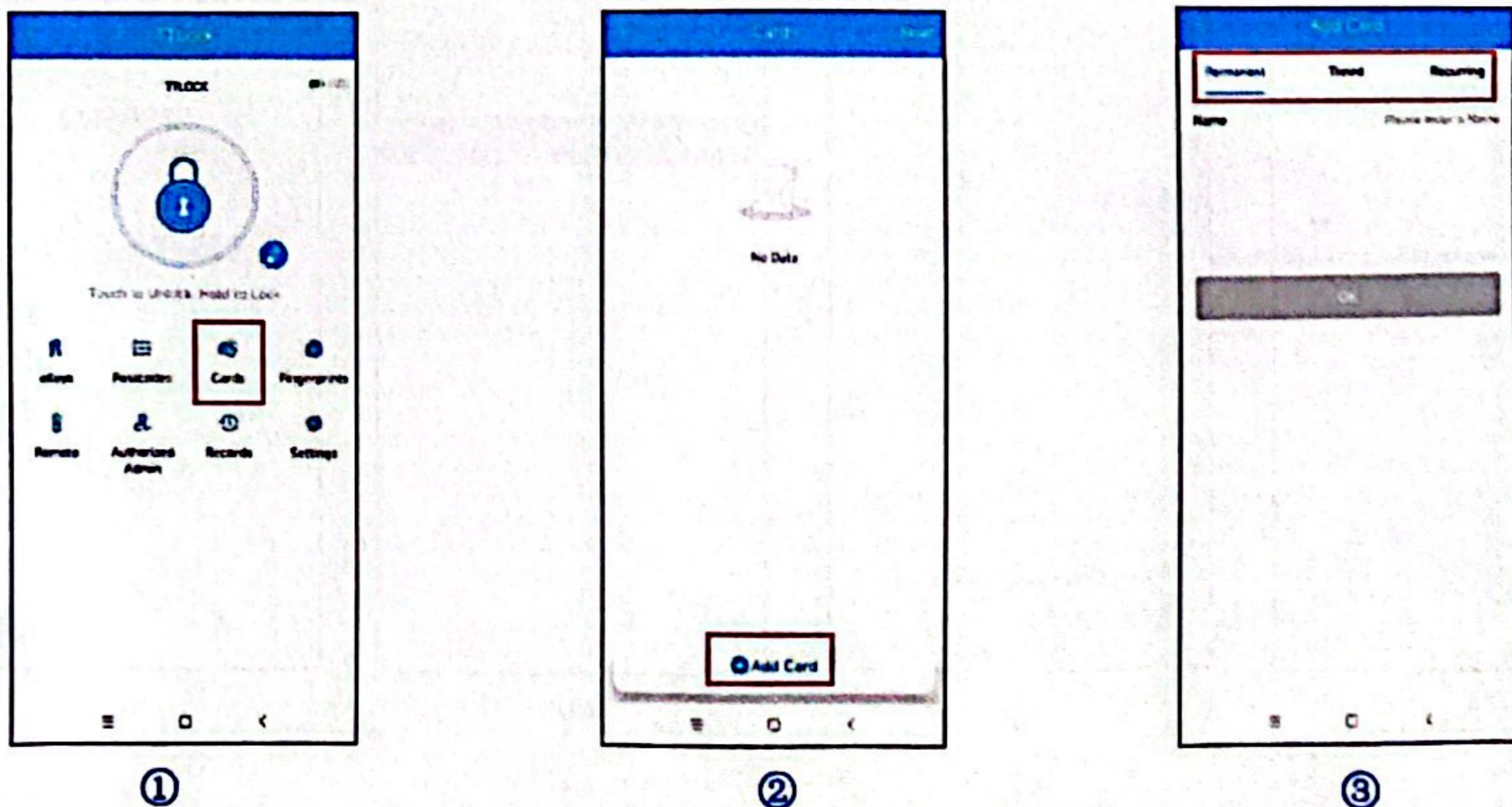

6.4.4. Add fingerprint

The premise that a fingerprint can be used to open a door is that it needs to be added first. The adding process needs to be performed by the APP beside the lock. The fingerprint expiration data can be set, it can be permanent, timed or recurring. After setting ,you can modify its validity period.

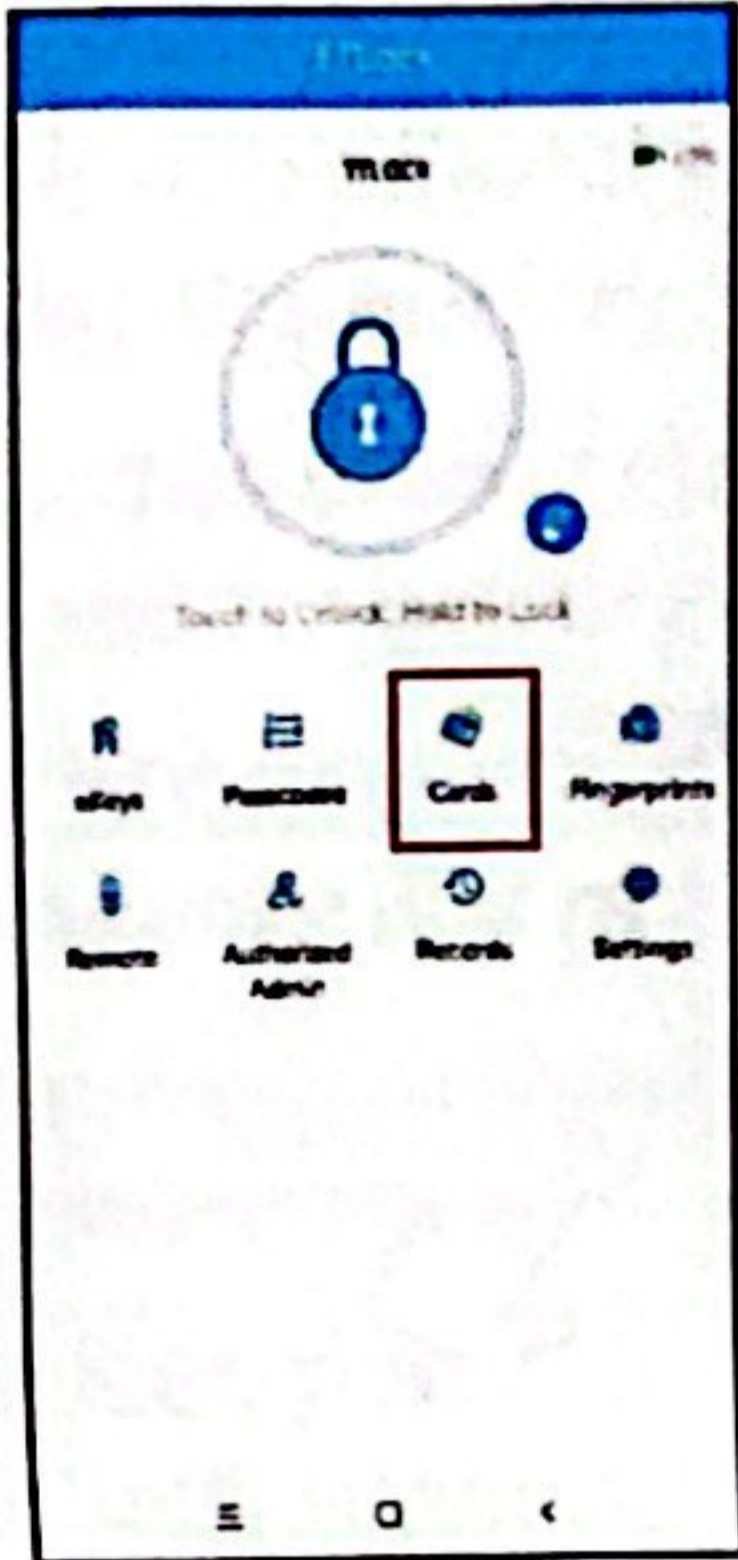

①

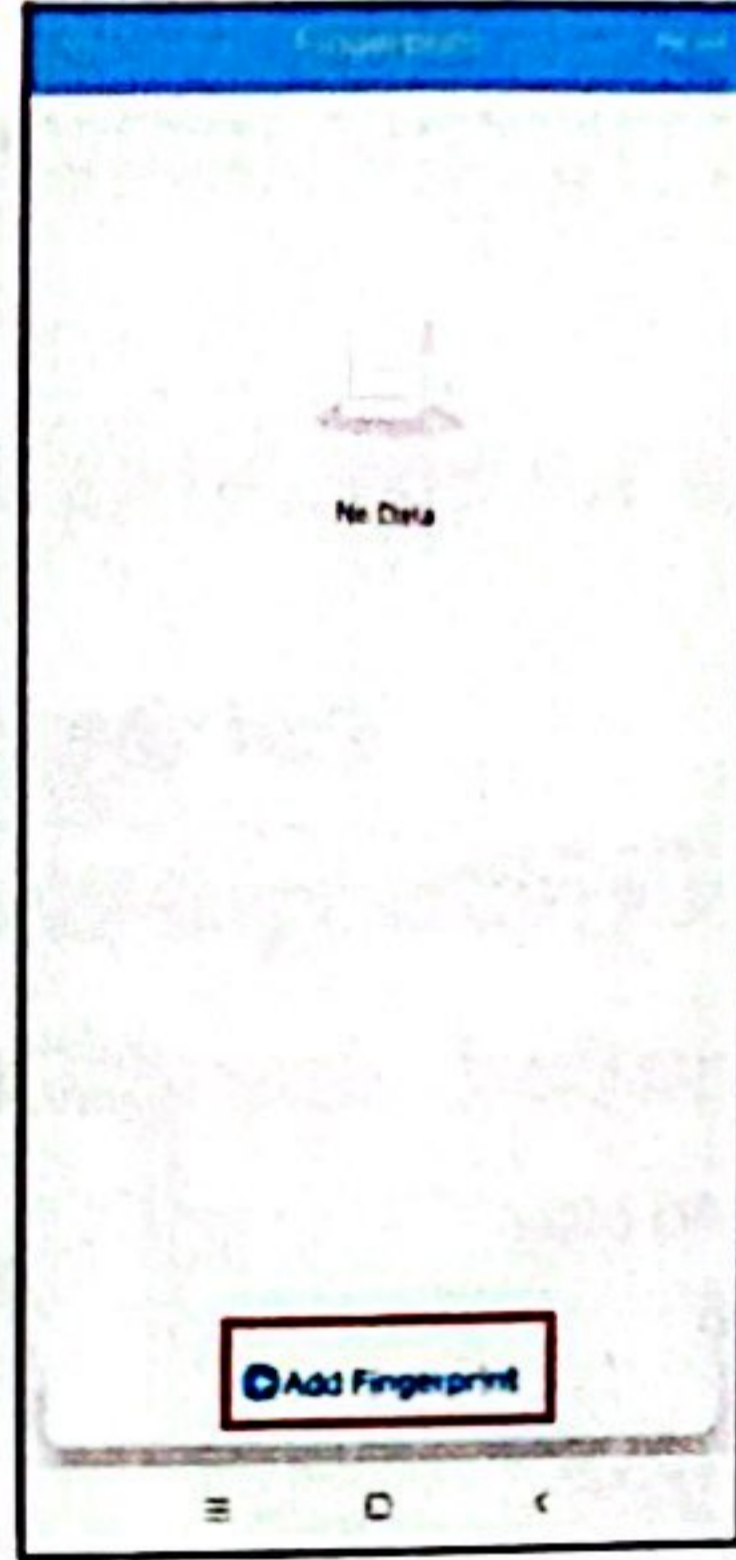

②

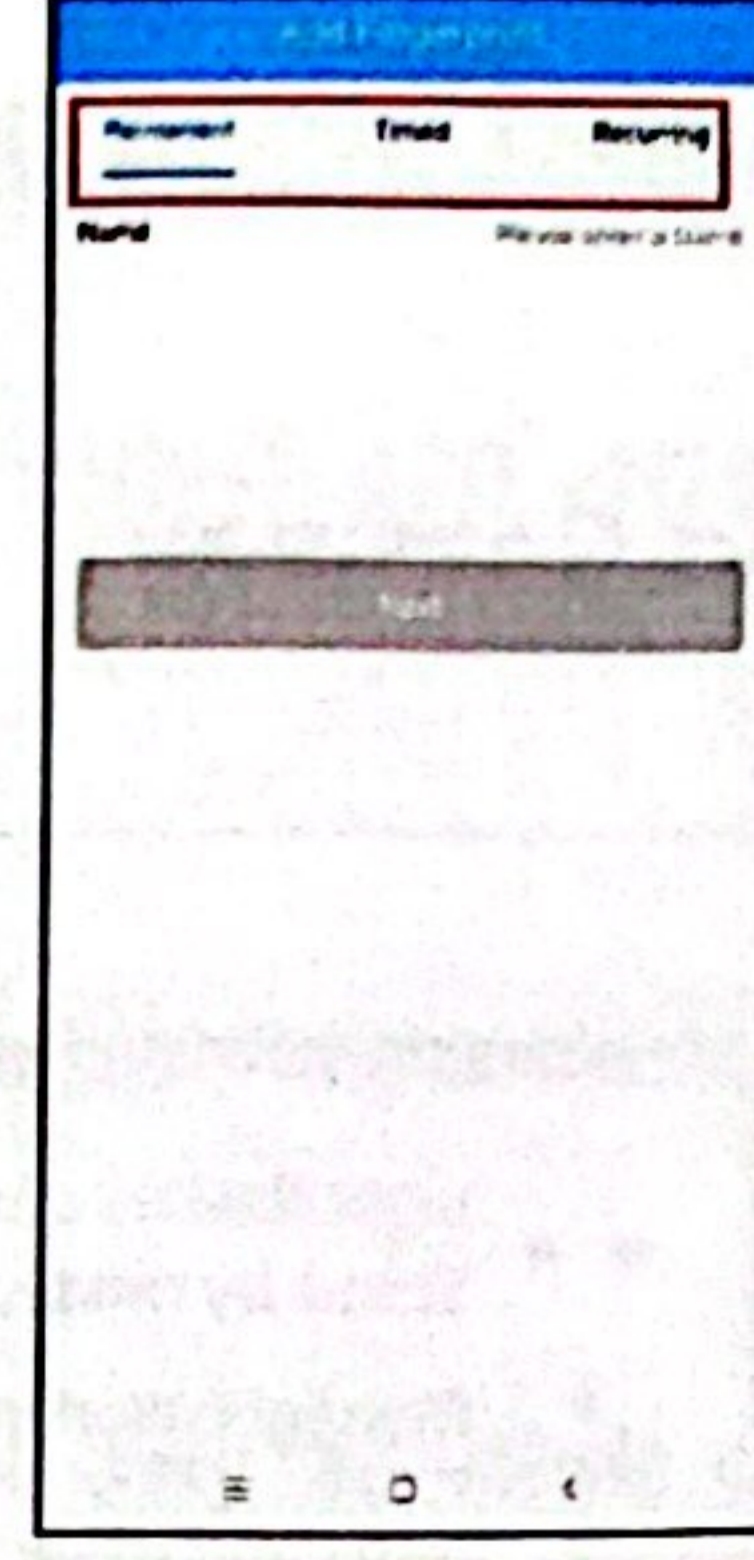

③

6.4.5. e-Key management

Click "  " The manager can delete ekey, reset ekey, send and adjust the ekey, meanwhile he can search the lock record.

6.4.6. Passcode management

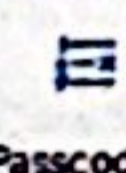
Click "  " .All generated passwords can be viewed and managed in the password management module. This includes a password change, password deletion, password reset, and password unlock record.

6.4.7. Unlock records

Click "  " you can query your unlock record as shown in figure.

Records

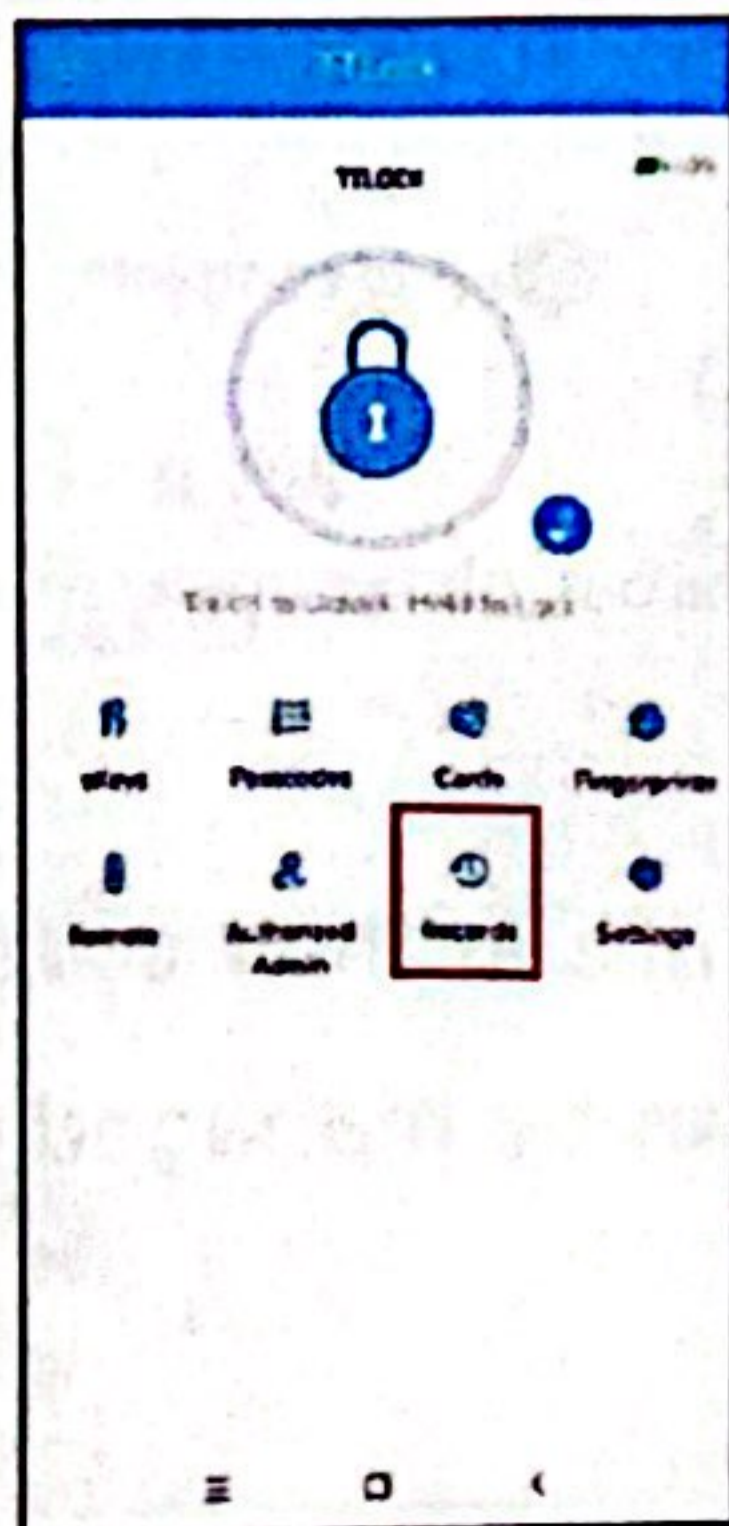

①

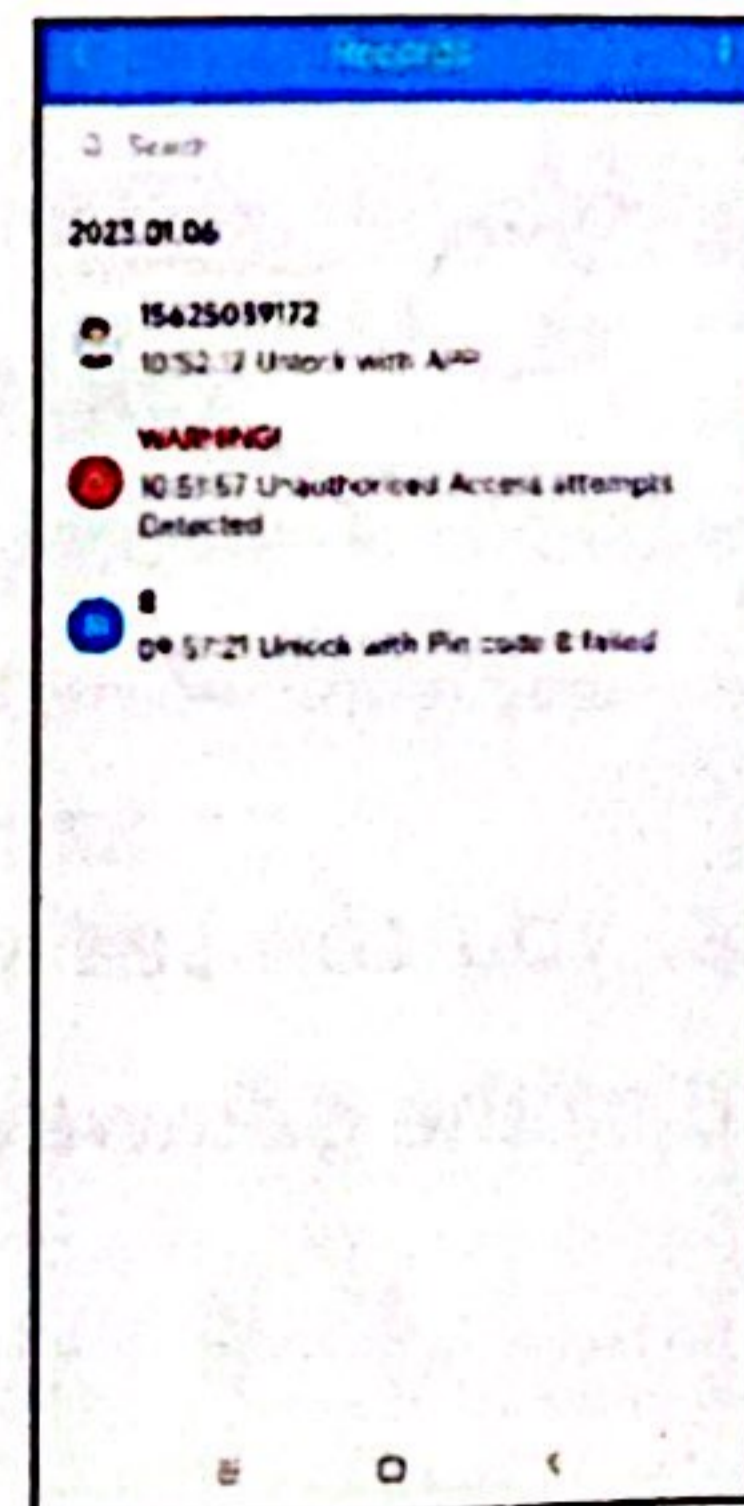

②

- Introduction
- Installation
- Operation**
- F.A.Q
- Appendix

6.5. Gateway management(Optional)

The TT lock is directly connected via Bluetooth, that is why it is not attacked by the network. The gateway is a bridge between smart locks and home WIFI networks. Through the gateway, the user can remotely view and calibrate the lock clock, read the unlock record. Meanwhile, it can remotely delete and modify the password.

6.5.1. Add Gateway

Light Status

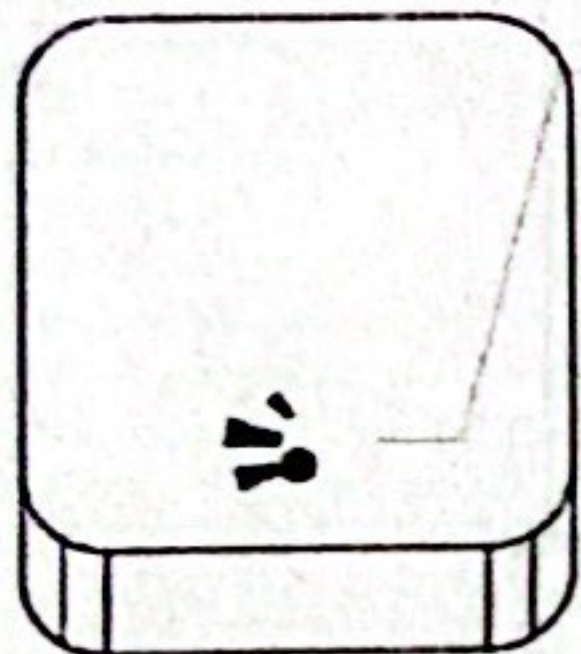

When the gateway is powered on:

- Light flashes alternately in red and blue: Stand-by mode, ready for pairing
- Blue light: Working mode
- Red light: Network failure

Pair the Gateway with APP

1 Activate the APP

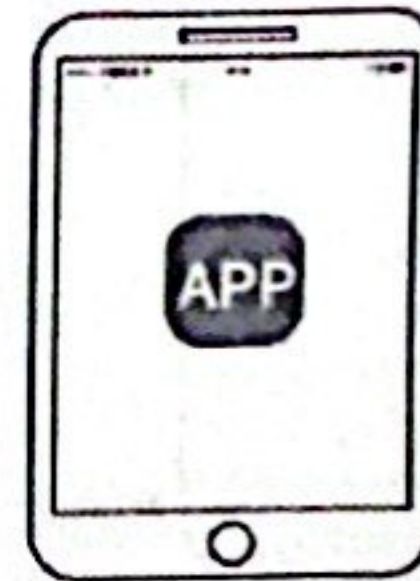

2 Press "☰"



3 Select [Gateway]

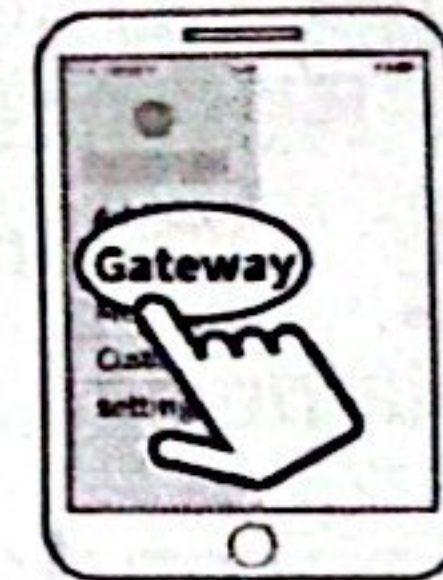

4 Select [G2]

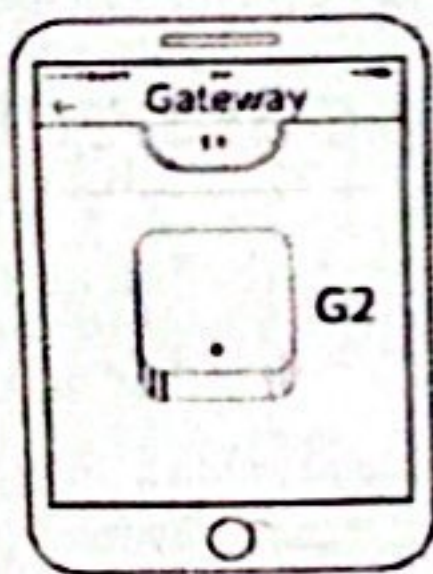

5 Plug in the gateway and power it on, while the light flashes alternately in red and blue

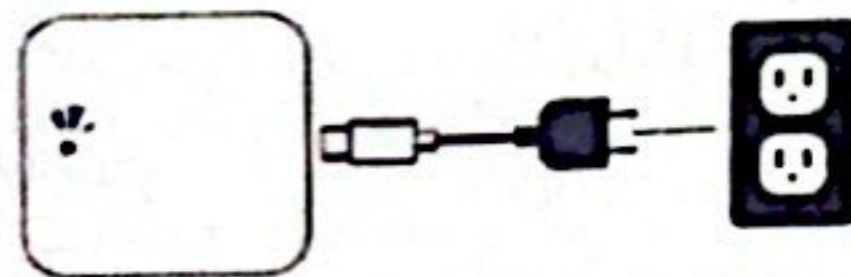

6 Press "+" sign



7 Add Gateway



8 Select the network and fill in the password

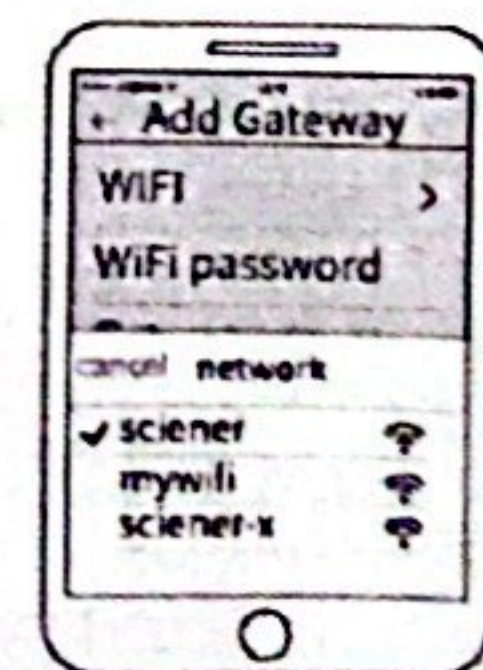

9 Add complete

⚠ Notice: If times out, please power off and try it again.

6.5.2. Manual

After a short period of time, you can see which locks are in their coverage in the app. Once the lock is bound to the gateway, the lock can be managed through the gateway

7. Reset the Lock

Please note all date will be erased if you reset your lock to factory default.

8. Replace Batteries

Please use 4 high-quality alkaline AA batteries for replacement when the battery is dead.

9.5V Emergency Power

Micro USB interface is used to connect regular 5V power bank to activate the lock in case the battery is dead.

Note: The Micro USB interface is only used for emergency unlock and cannot be used for battery charging.

10. Emergency Key Unlock

Emergency key can be used when the battery is dead.

Note: Keep at least one key outside your house so you can get it to unlock in case of emergency.

11. Keypad

The lock supports up to 16-digit Vague Code. Just enter any 16-digit code, as long as a correct code is include in what you entered, you can open the door.

12. Unlock From Outside

① Fingerprint

Place your finger on fingerprint reader to unlock.

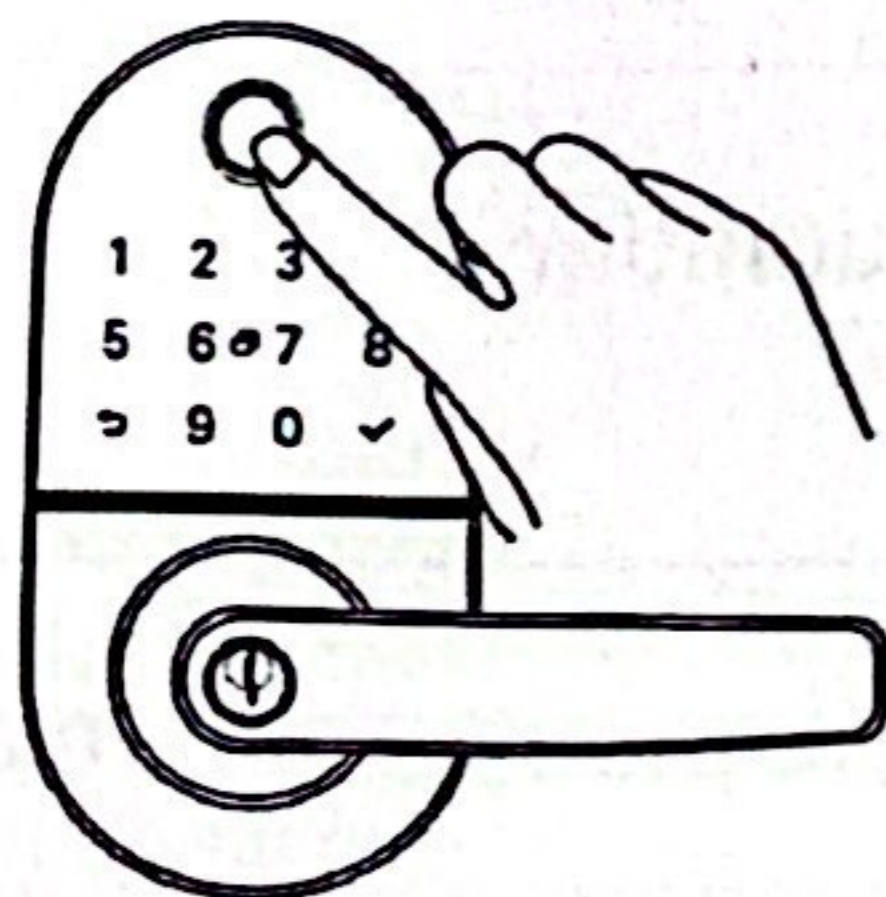

② User Code

Enter 6-9 digit code and to unlock. (You have set the unlock password in step.

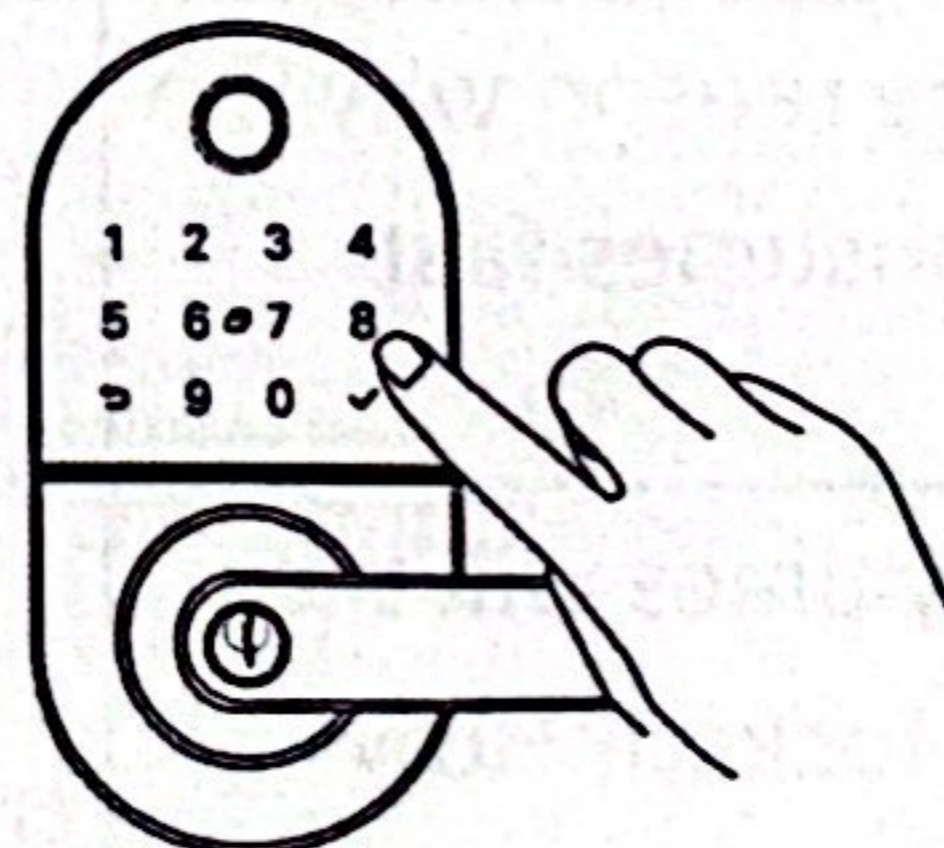

③ Card

Swipe your card on the keypad of the lock to unlock.

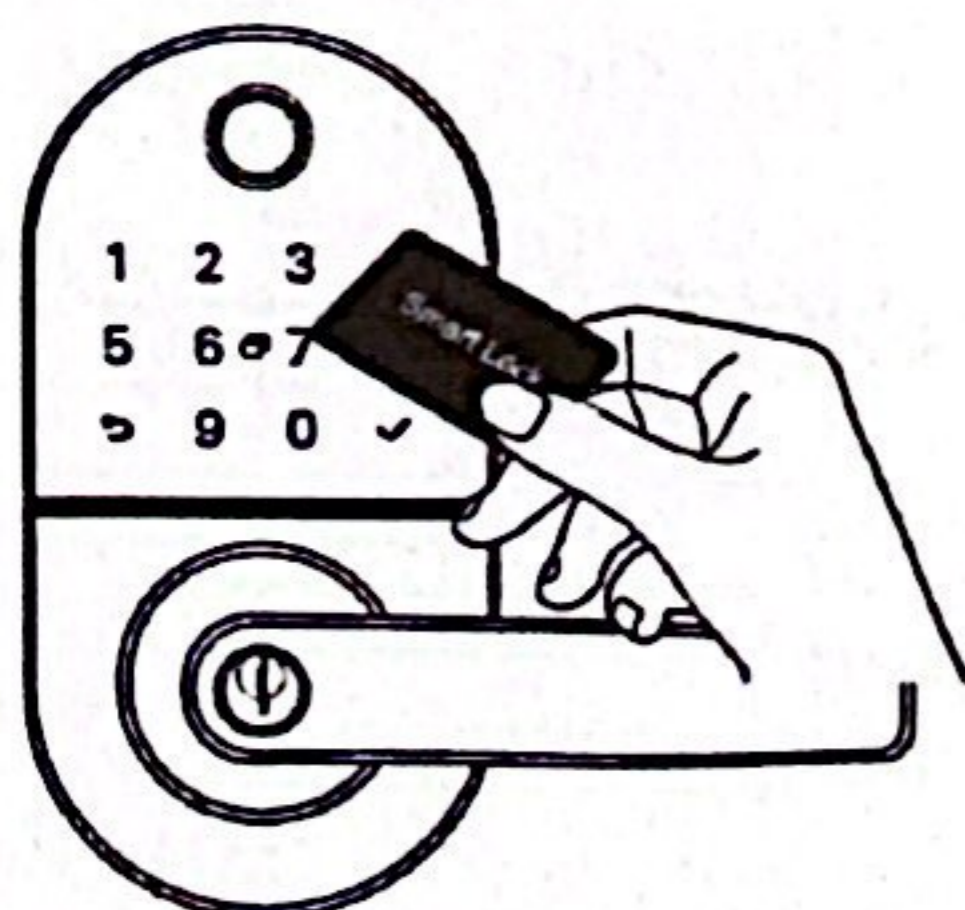

④ Mechanical key

Insert the key into the lock cylinder hole and rotate it 90 degrees counterclockwise.

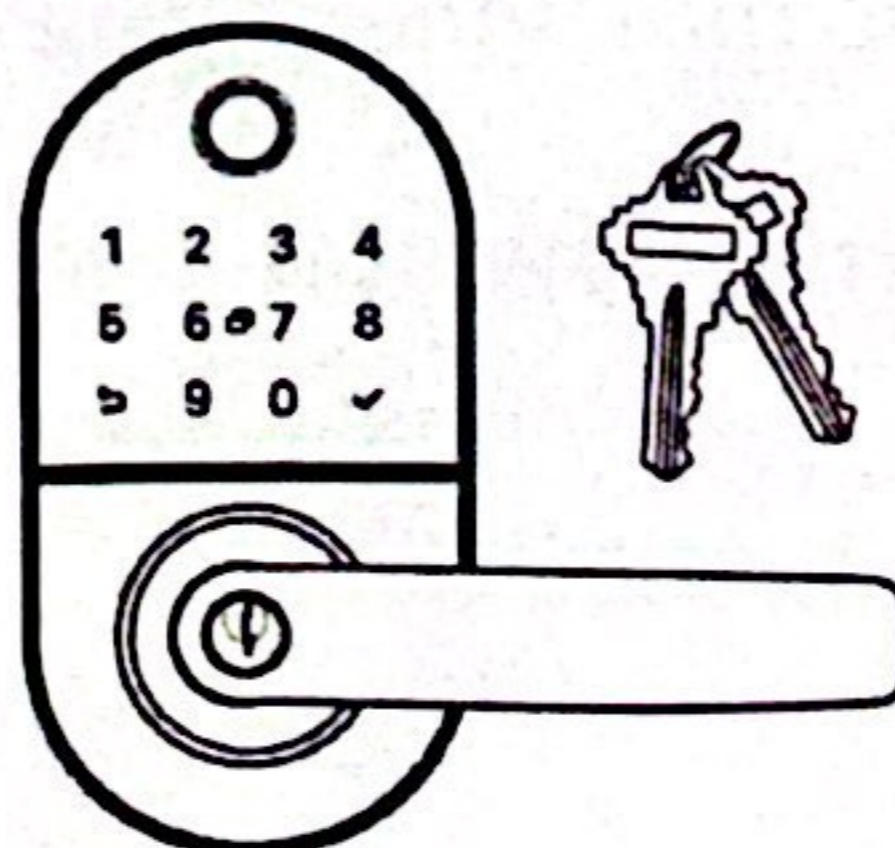

⑤ Smartphone

Use your smartphone to unlock. Please refer to the guide in TLock App

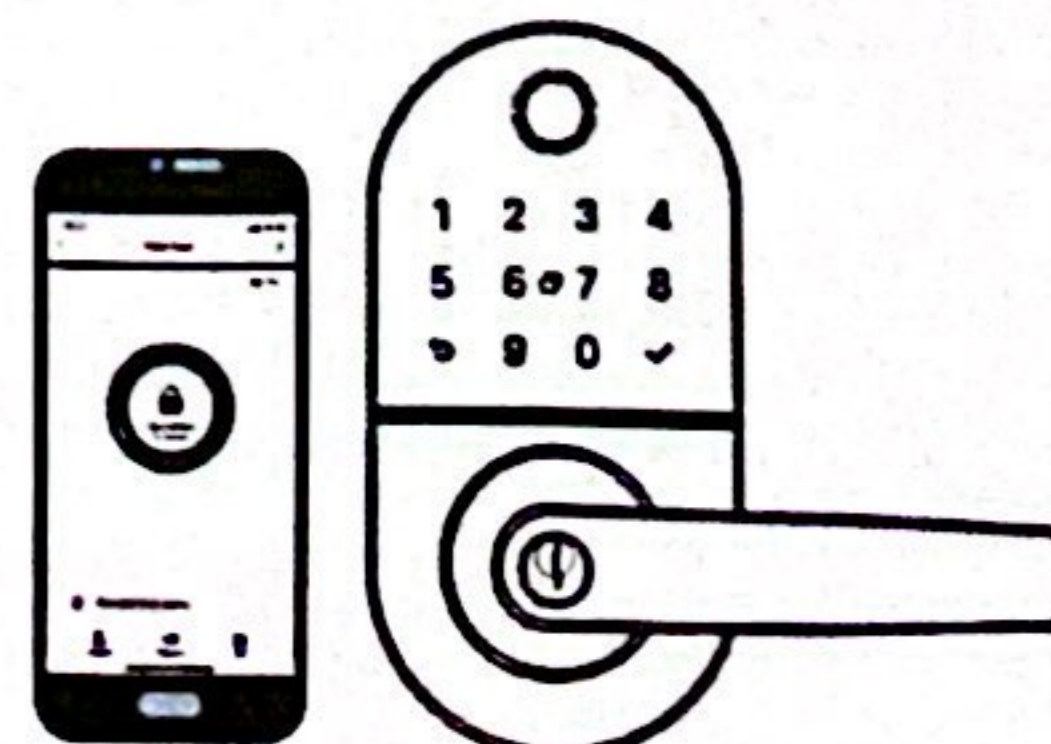

13. FAQ

1) How to read operation records?	In the Records of the main interface.
2) Why can't I unlock it after open the passage mode	You need to perform an unlock verification in any method, then the passage mode will take effect.
3) What is the purpose of Auto Lock	You can set how long to lock after unlocking
4) After installation, touch sensing keyboard, screen no respond	<p>a) In this case, first check that the positive and negative electrodes of the battery have been installed upside down, whether the battery has enough power</p> <p>b) Remove the back panel and see if it's connected</p> <p>c) To eliminate the above situation, you need to remove the lock ,check whether the wires of the lock body are squeezed, and the re-wire</p>
5) Unable to register fingerprint	Check the fingers for dirt or wear, check the fingerprint head on the lock for dirt and oil stains, etc. Check to see if the fingerprint is working properly(Press to see if there is any responds.
6) What is the reason why the smart lock consumes fast power?	<p>a) Large standby power consumption</p> <p>b) Short circuit</p>
7) How many times will the password be locked? How long is it locked?	Enter the wrong password more than 5 times in a row, the keyboard is locked for 90 seconds

Introduction

Installation

Operation

F&Q

Appendix